

PSRIP
GRADE 3
TERM 3 2021

FIRST ADDITIONAL
LANGUAGE
ENGLISH

RESOURCE PACK

WEEKS

1 & 2

Compassion

- nch

lunch

bunch

munch

punch

stench

bench

drench

pinch

ow

show

slow

slowest

grow

elbow

borrow

pillow

follow

friend

shy

friendly

include

exclude

lonely

alone

fit in

strange

invite

thankful

included

excluded

sibling

stranger

treat

want

need

deserve

decide

always

say

thought

about

strange

know

alone

proud

again

compassionate

compassion

thoughtful

classmate

everything

I showed
compassion
to . . .

I saw that he
/ she felt ...

So,

I . . .

I showed
compassion
because . . .

I felt ...

He / she

felt . . .

Compassion is
important
because . . .

WEEKS

3 & 4

Honesty

ow

down

crown

drown

brown

owl

growl

vowel

towel

-tch

thatch

catch

patch

match

sketch

fetch

witch

stitch

honest

honesty

truth

lie

lose

find

belong to

owner

bracelet

sparkle

keep

give back

cheat

steal

admit

kneel

kneelt

guilty

found

liar

betray

trust

lost

found

beautiful

missing

now

home

that

looked

fell

kneelt

dishonest

betrayed

I once lied

to . . .

I lied

about . . .

I said . . . even
though . . .

I lied

because . . .

I felt ...

In the

end...

WEEKS

5 & 6

Solving problems

ew

new

grew

flew

chew

chewed

few

fewer

stew

ir

sir

stir

bird

third

skirt

chirp

dirty

first

windmill

plastic

metal

suffer

drought

drop out

starve

build

mocked

pipe

energy

famous

afford

article

lightbulb

radio

well

difficult

young

enough

bring

easy

finally

began

pump

water

wait

electricity

impressive

determined

impressed

journalist

invention

scrap yard

The problem
was that . . .

I wanted to
solve this
because . . .

I

decided...

First . . .

Then . . .

In the

end...

WEEKS

7 & 8

**Learning
new things**

str-

stretch

strong

string

strip

stripe

stray

strayed

know

learn

question
↓

internet

phone

tablet

search

read

watch

video

article

library

librarian

borrow

research

expensive

cheap

own

ask

usually

loved

seeds

how

properly

waste

what

search

learnt

seen

loved

stretching

computer

bookstore

information

different

resources

Questions I want to
search on the internet:

1.

2.

3.

Pictures I want to find
on the internet:

1.

2.

3.

WEEKS

9 & 10

Identities

ur

church

curly

surf

hurt

burned

turnip

murder

burst

scr-

scrap

screen

scream

scratch

scrunch

identity

gender

race

unique

separate

fit in

belong

allowed

comedian

belief

law

illegal

crime

bridge

business

outsider

funny

hang out

size

medium

religion

children

allowed

child

unfair

only

why

where

who

scared

places

when

scratched

screaming

chameleon

connection

Dear _____,

Hi! We have been
learning about . . .

Something
important about
my identity...

I

1

1

1

2 questions

(Who, what, when, why,
how?)

I hope...

Love, _____

WORD

FAMILIES

- ewed

- ewer

- inch

- ing

- ipe

- ir

- ird

- irp

-irst

-irt

-irty

-nip

- ong

- ow

- owel

- owl

- own

- unch

- urch

- urf

- urly

- urned

- urst

- urt

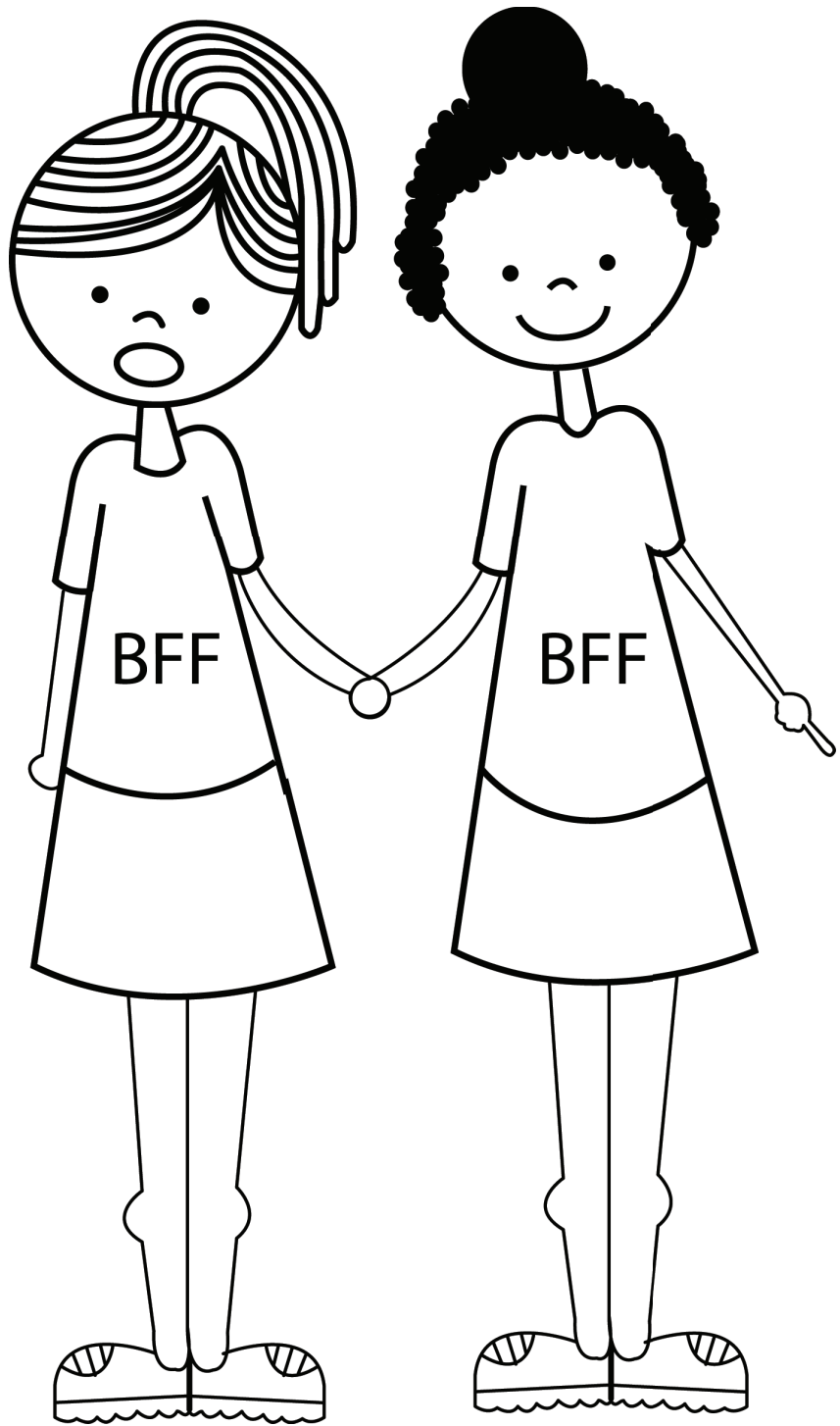

friend



compassionate

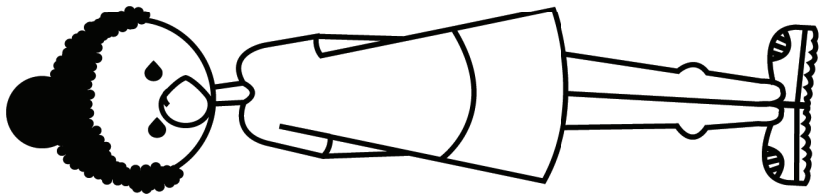
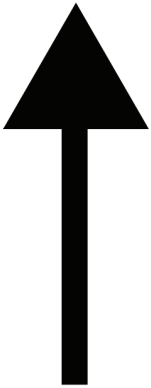
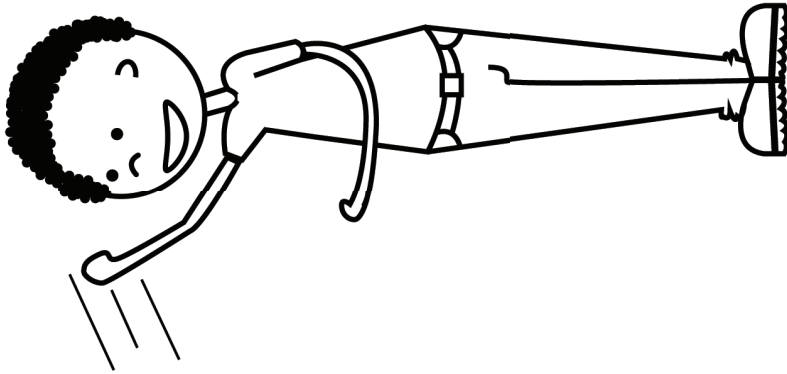
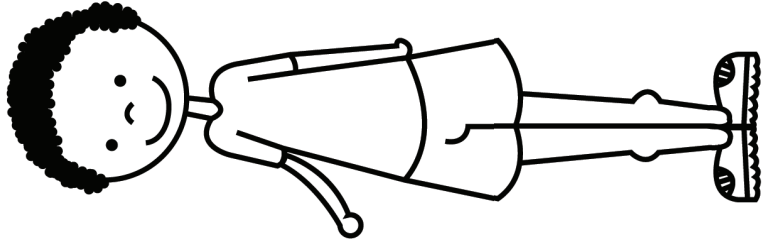
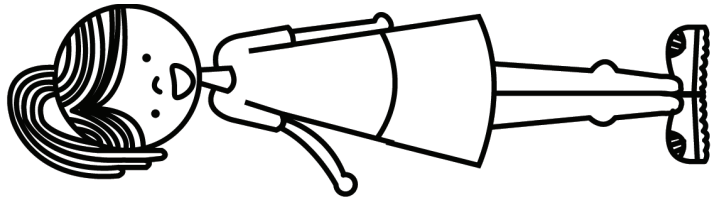

include

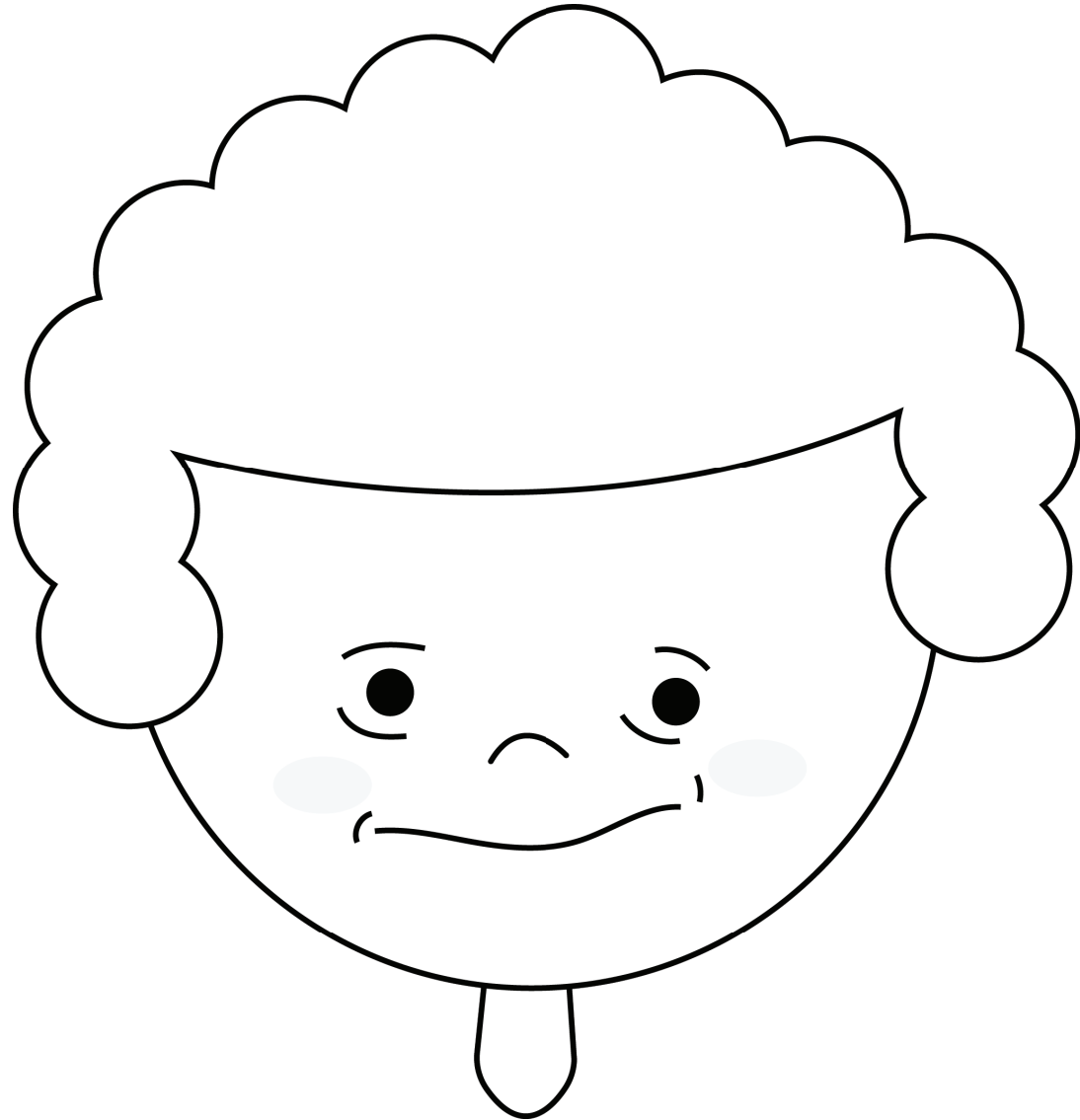

shy

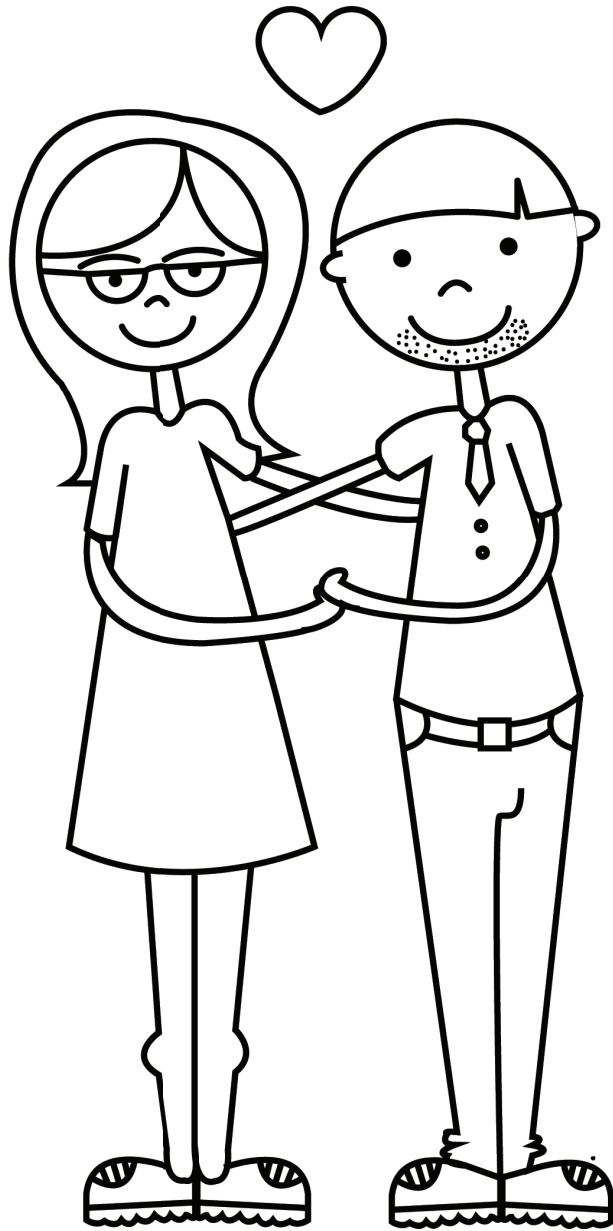
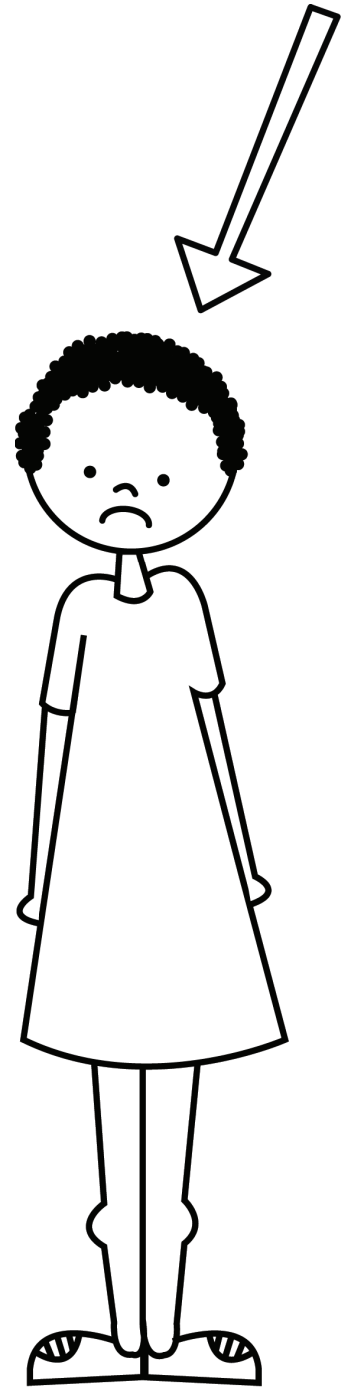

lonely

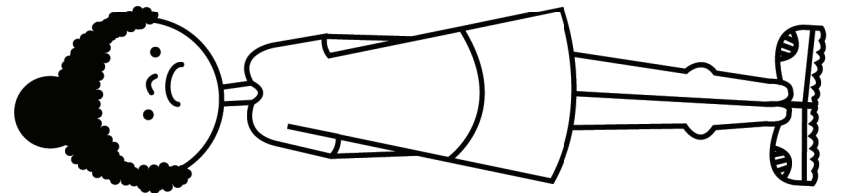
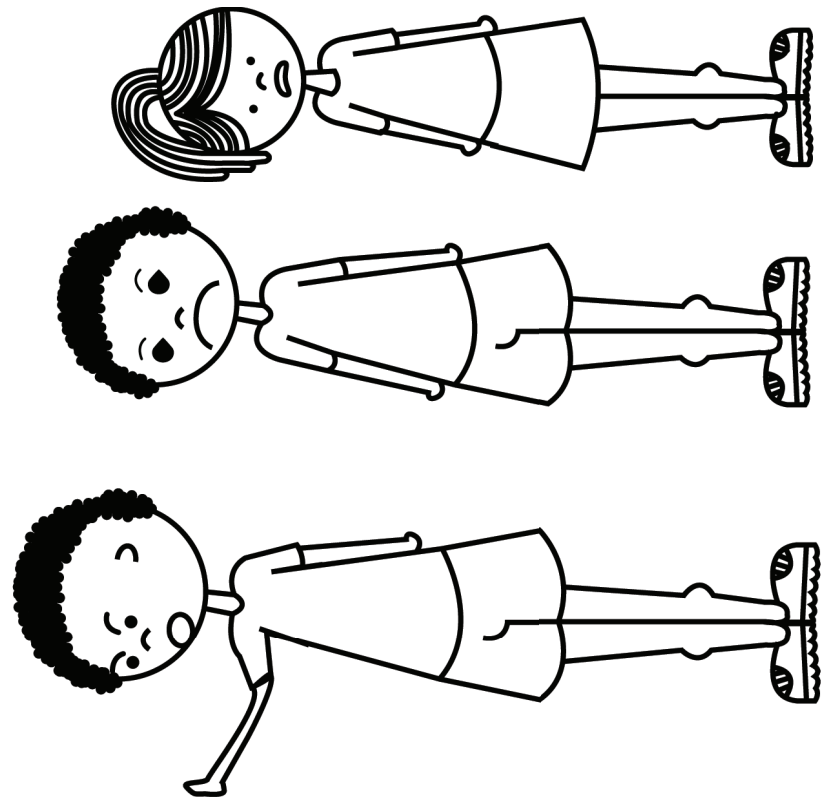

exclude

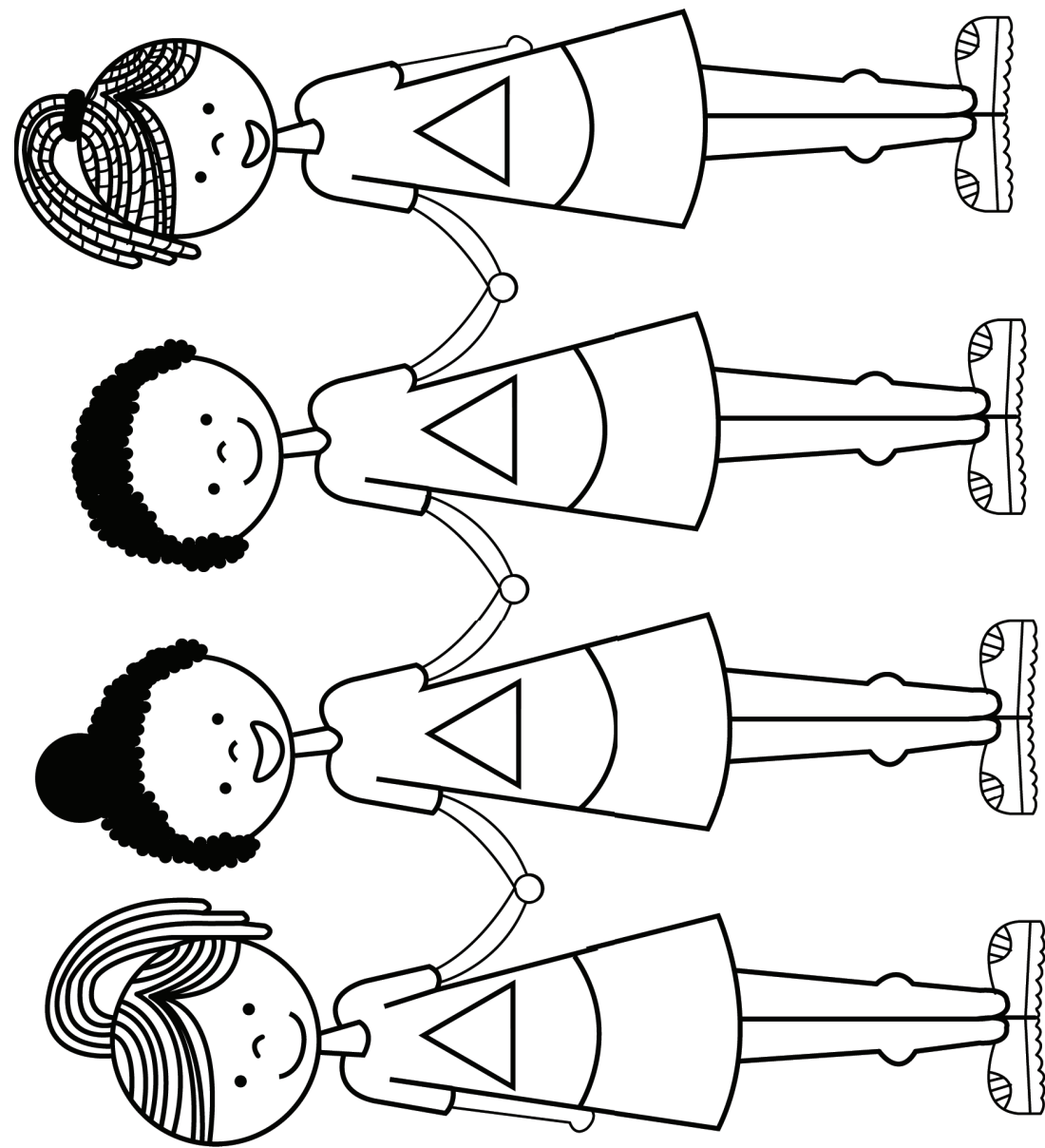

fit in

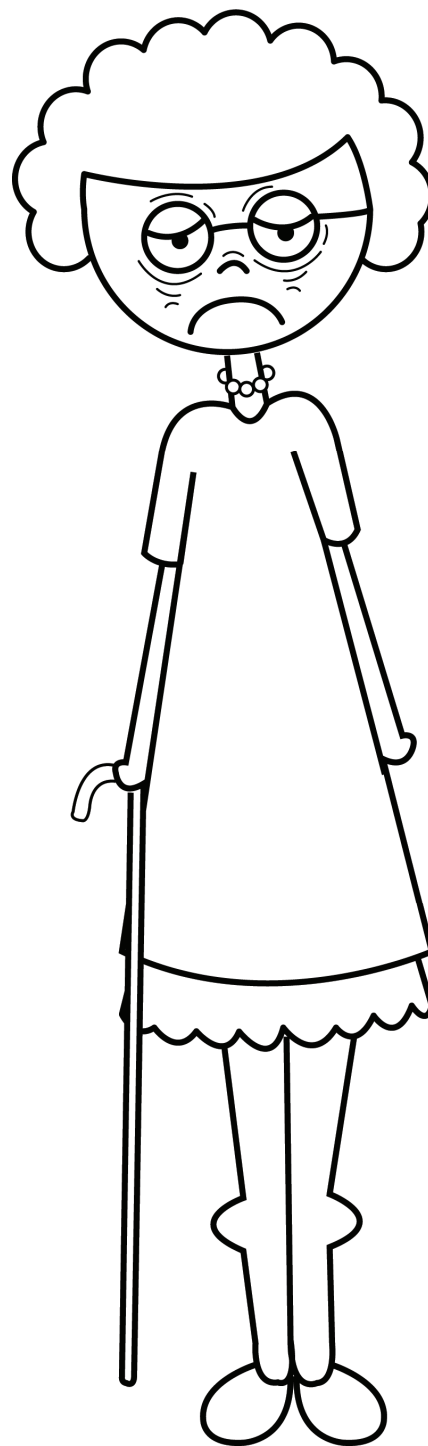

alone

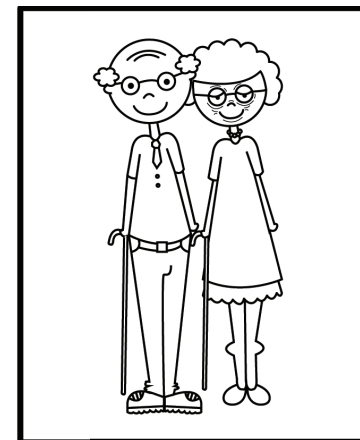

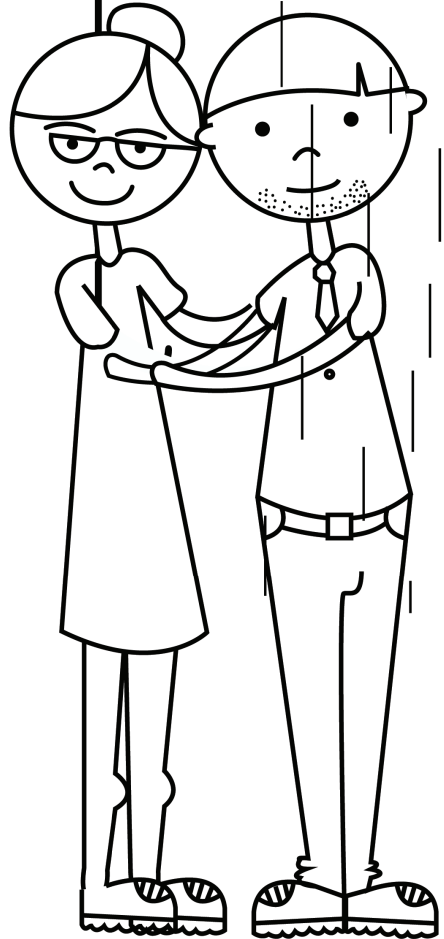
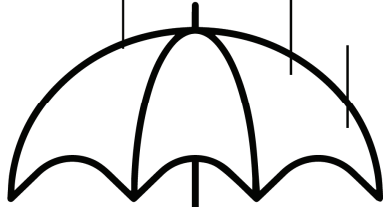

thoughtful

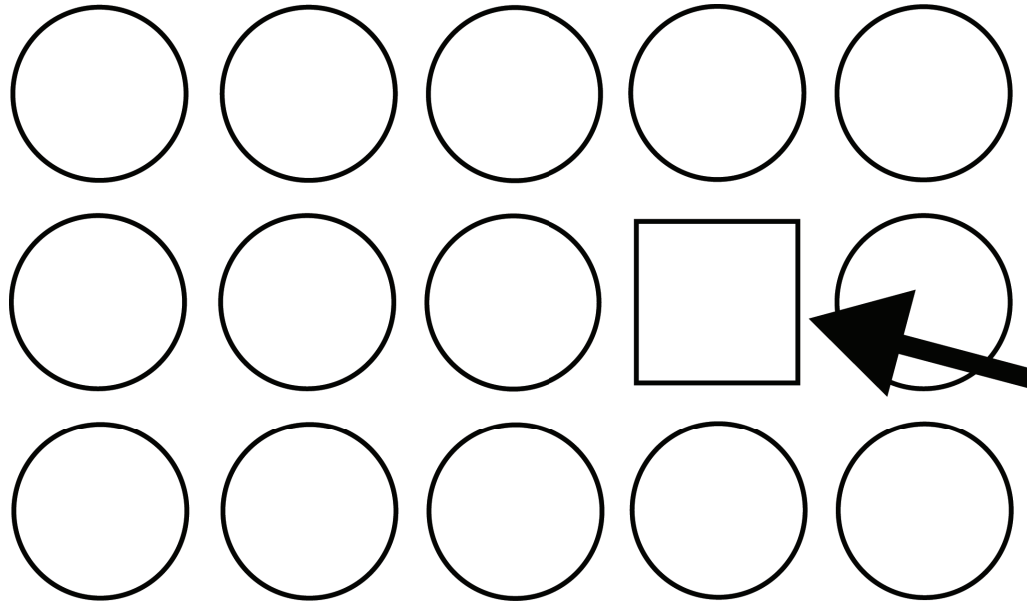

strange



thankful



invite



stranger

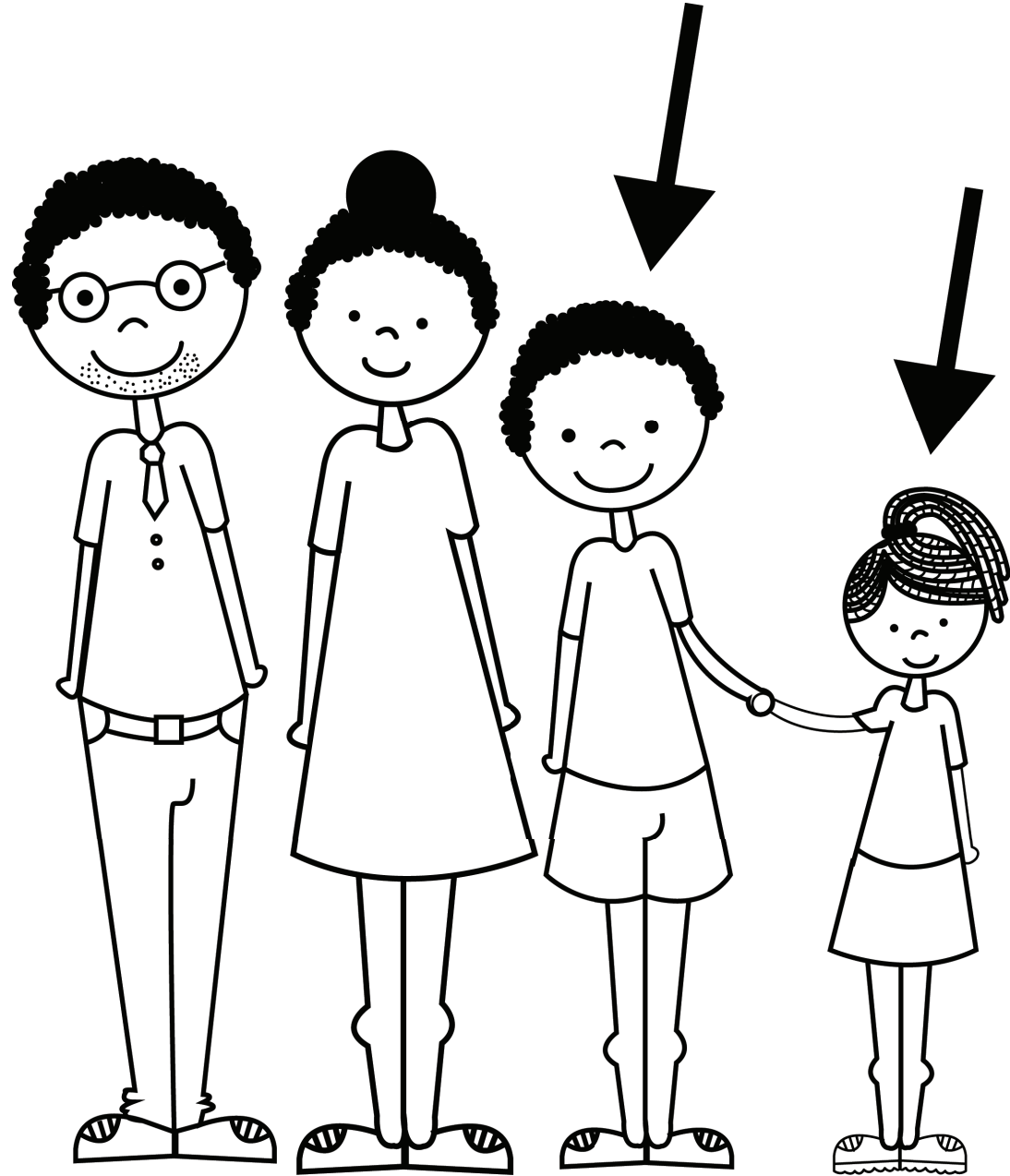

sibling

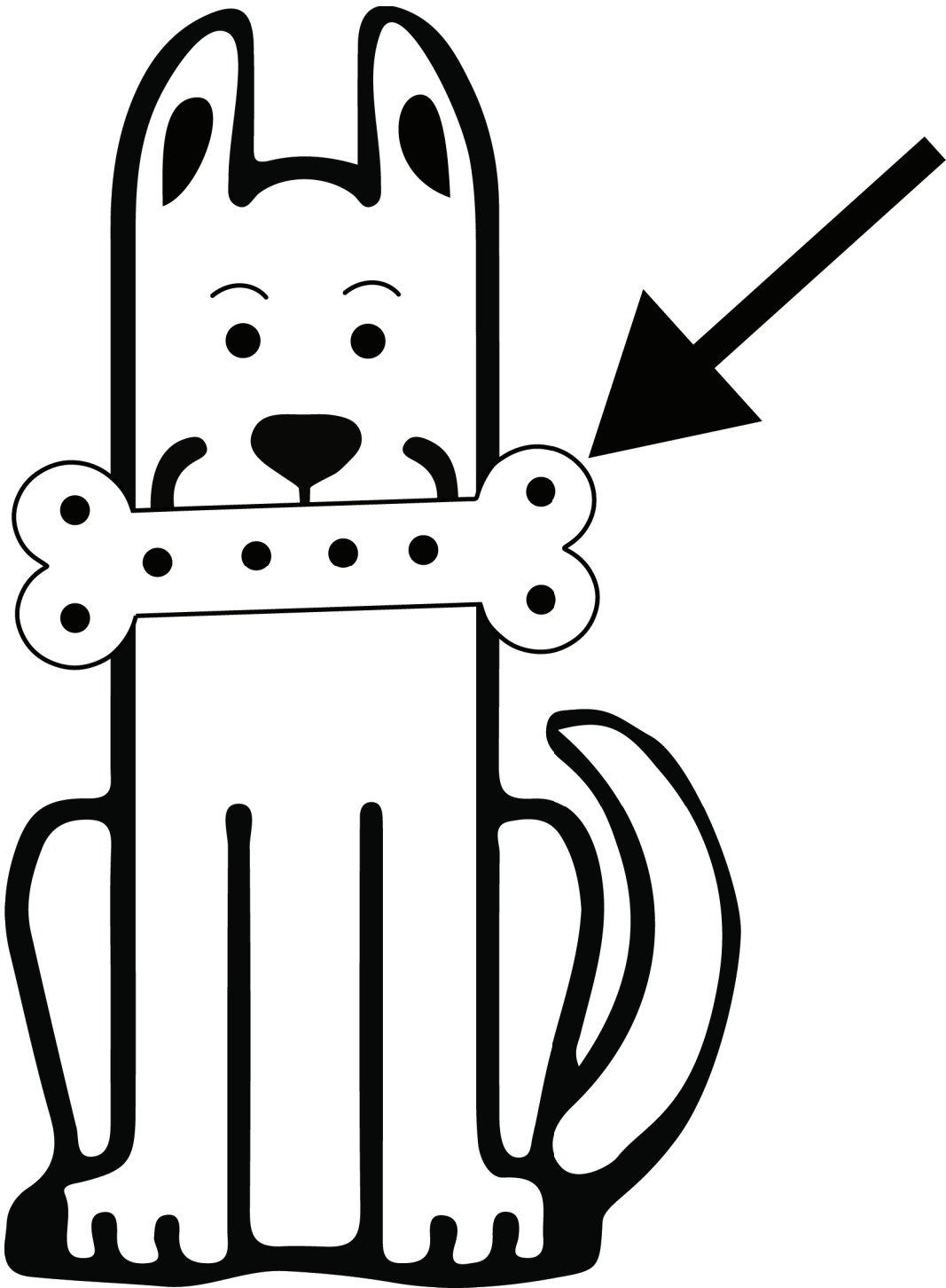

treat

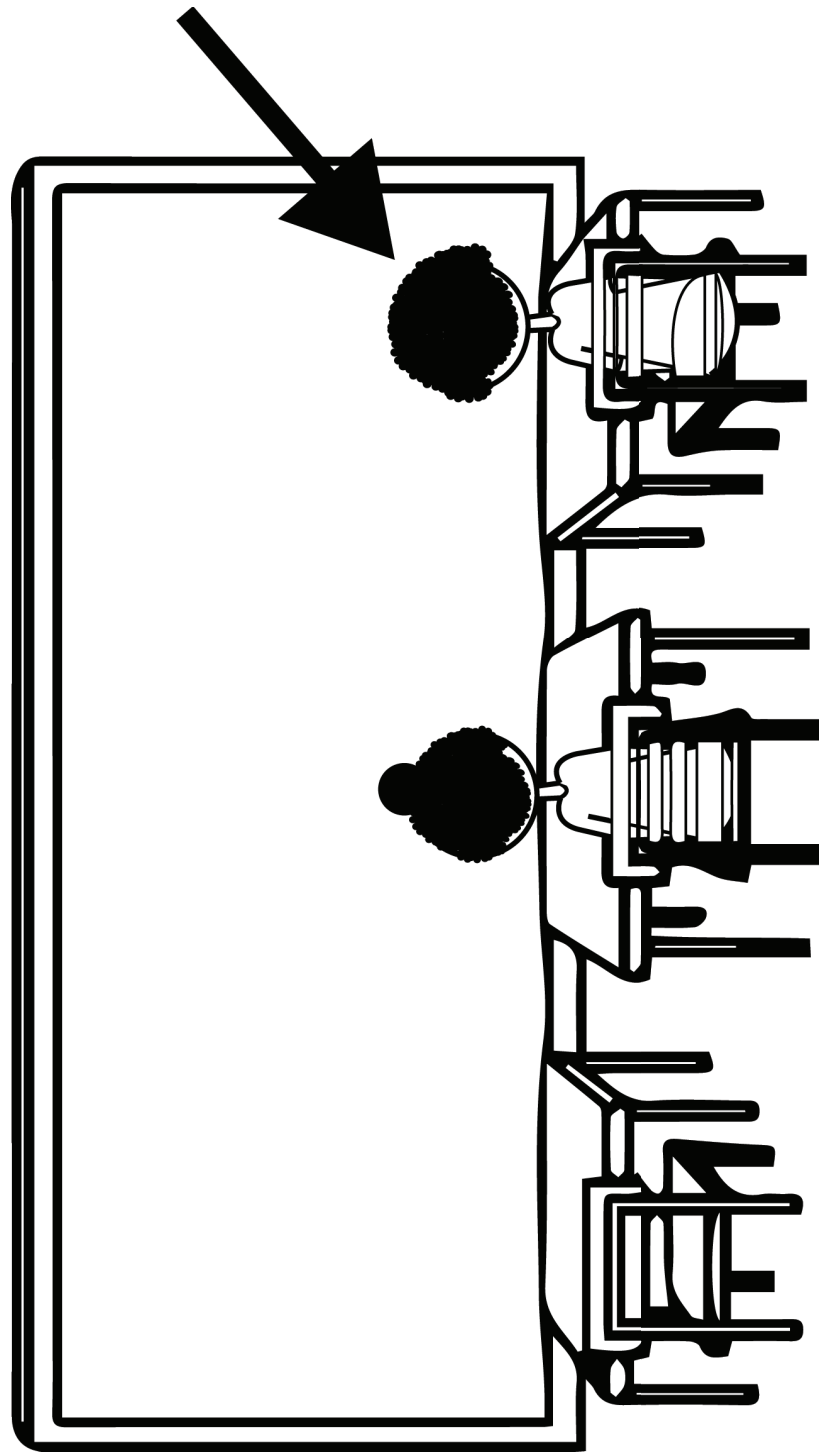

classmate

YES?

NO?

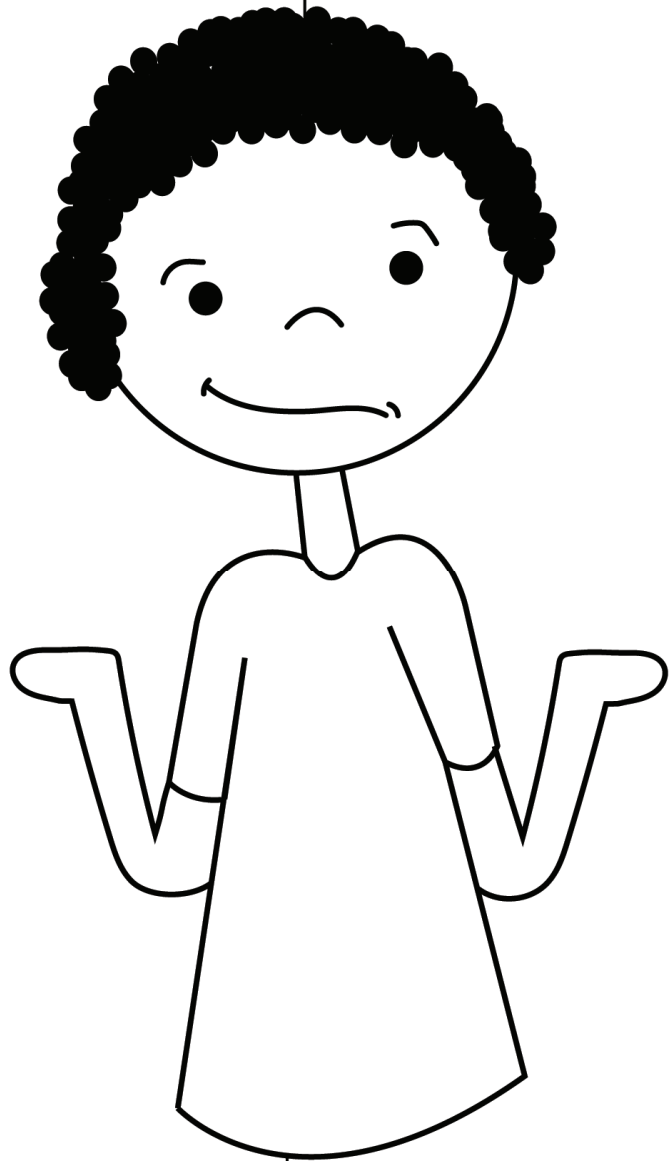

decide



want



truth

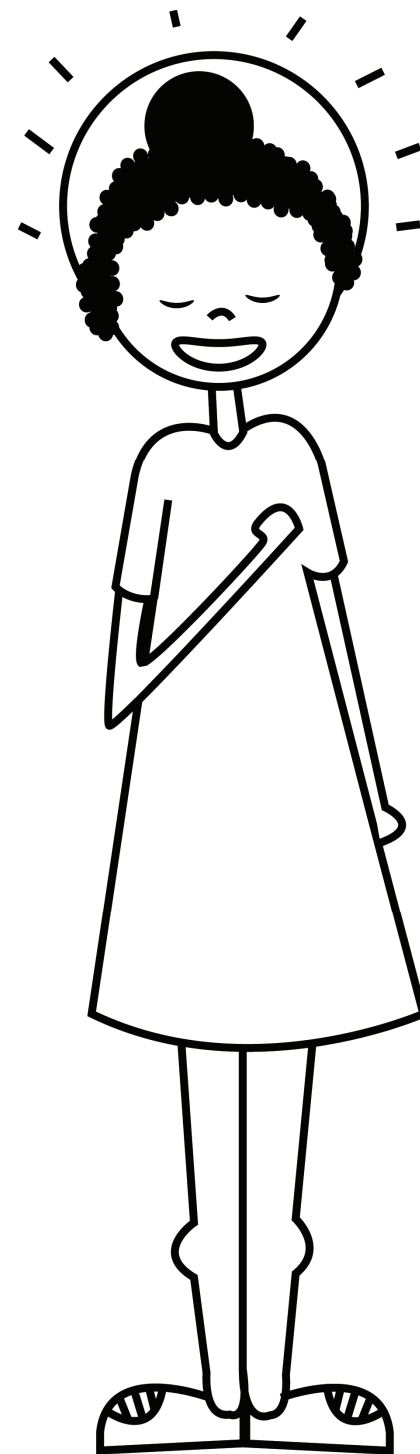

honest



lose

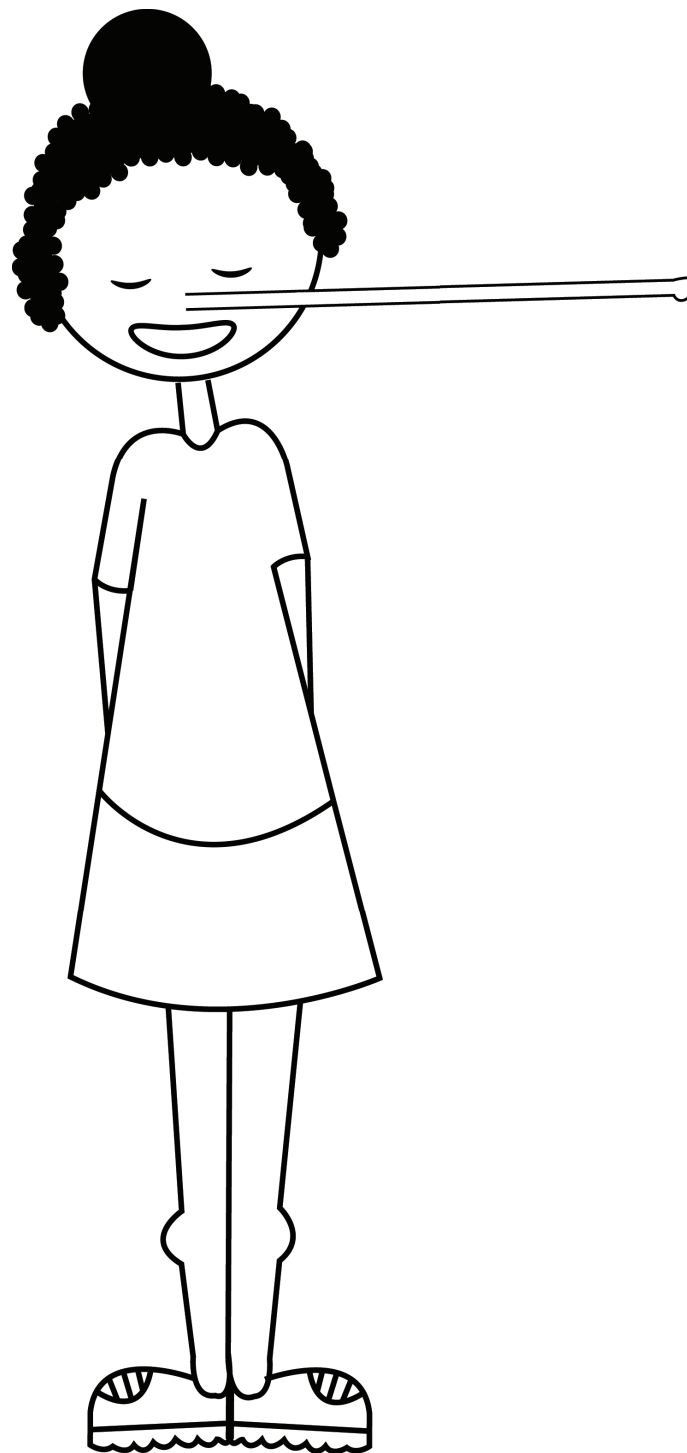

lie

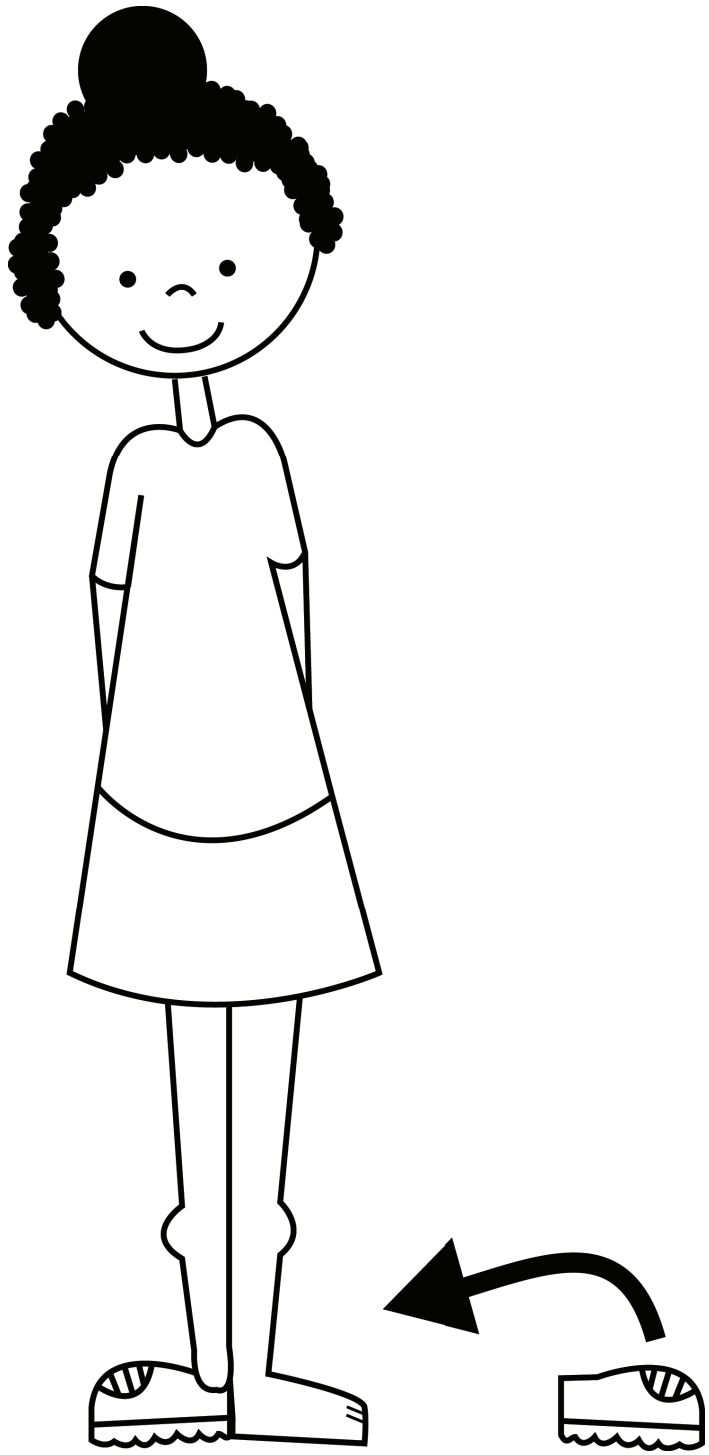

belong to



find

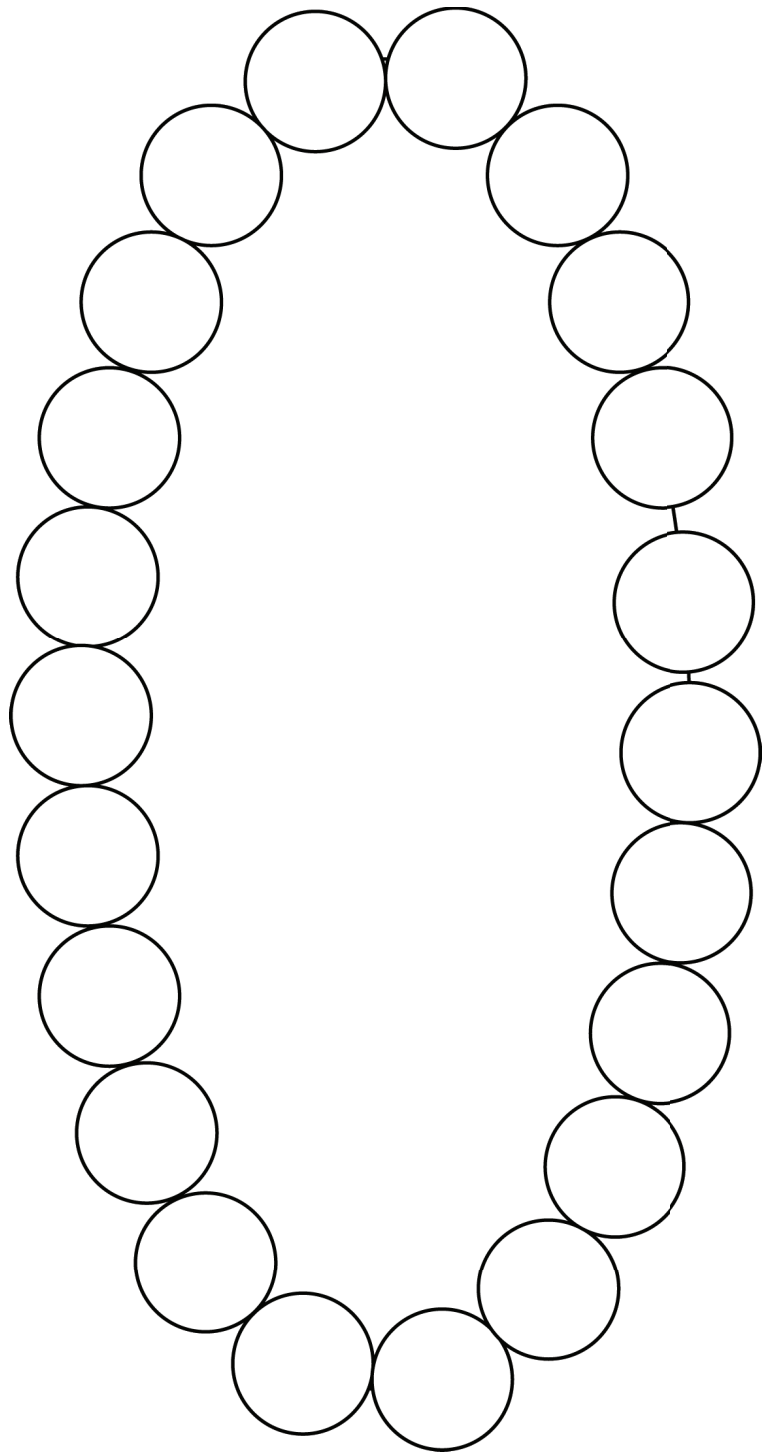

bracelet

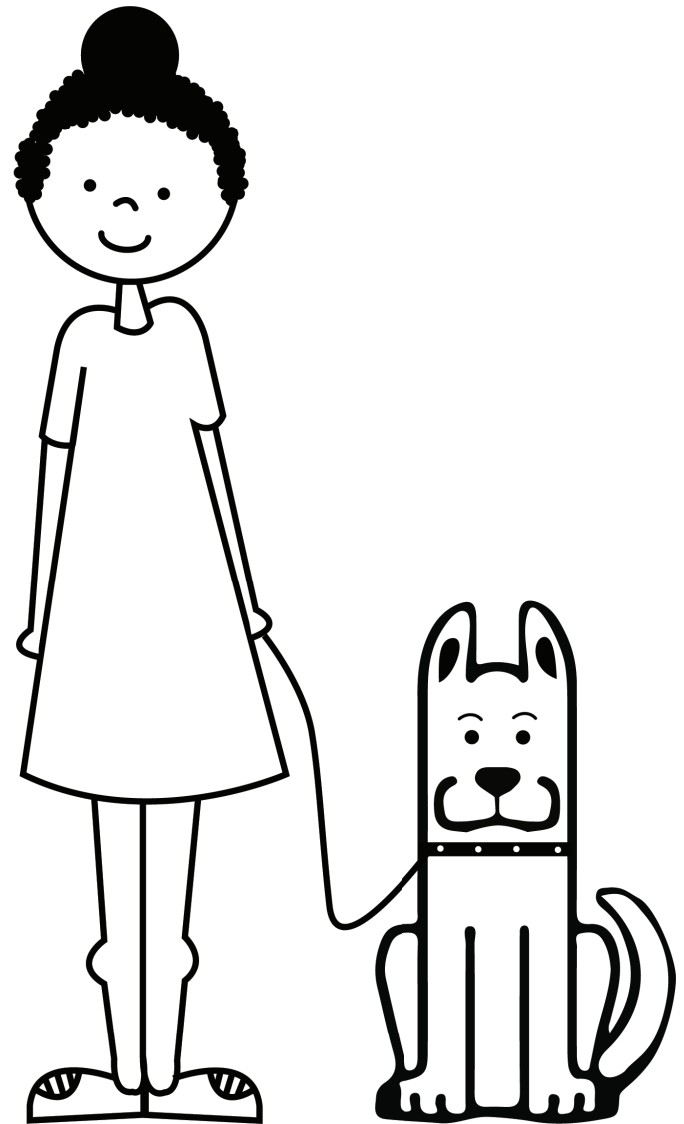

owner



keep

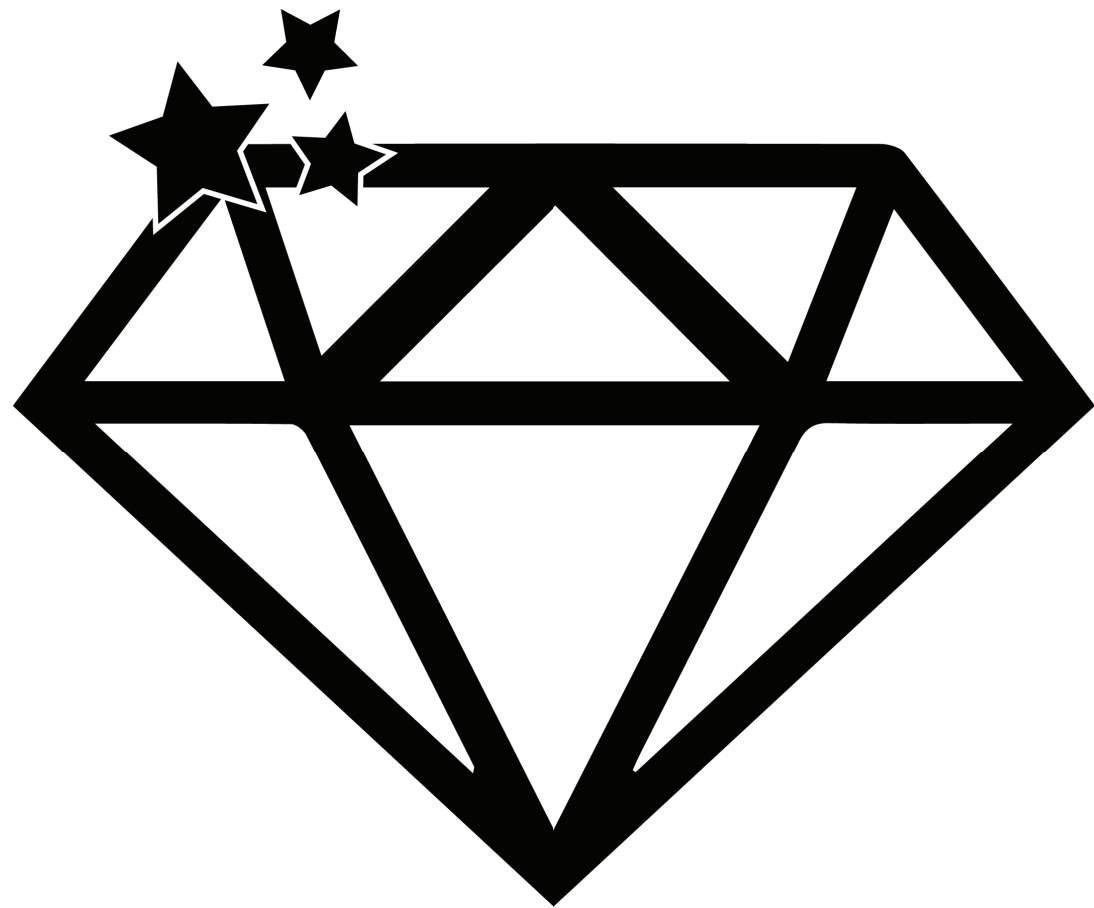
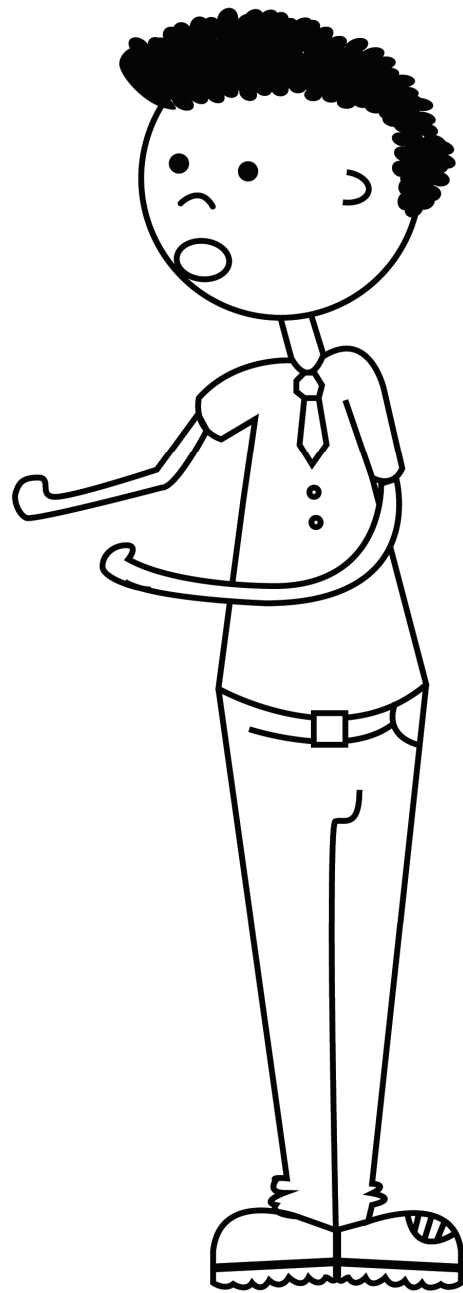

sparkle



dishonest

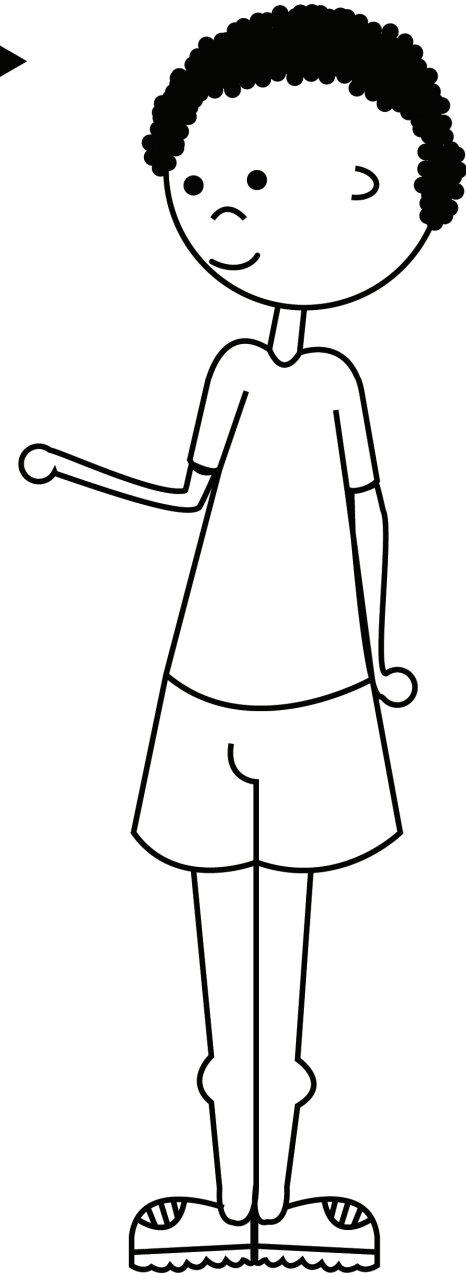
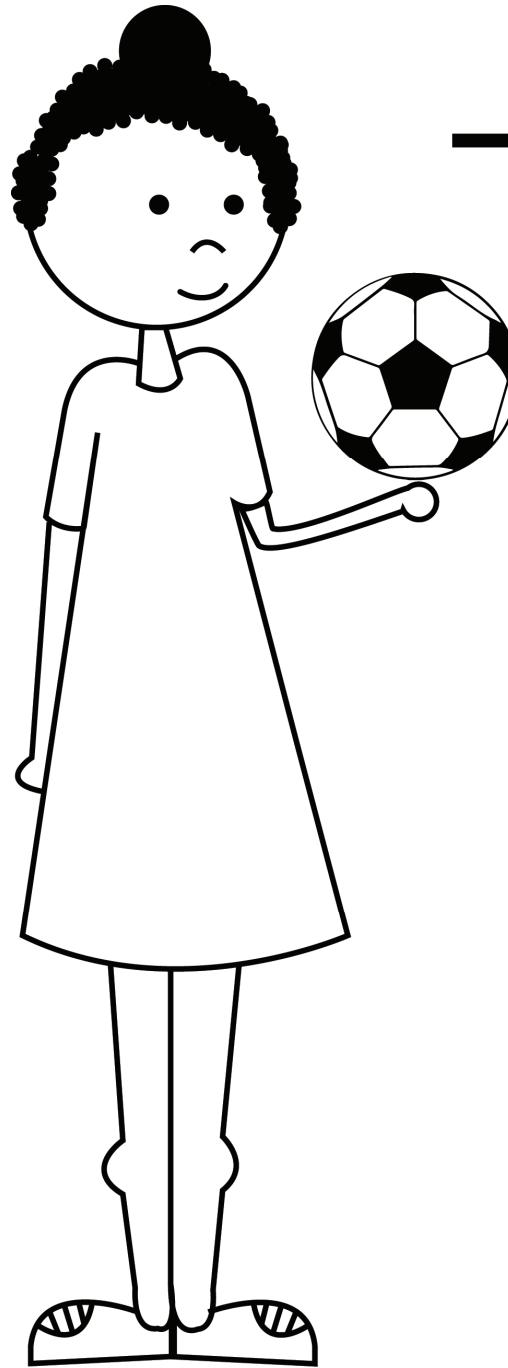

give back

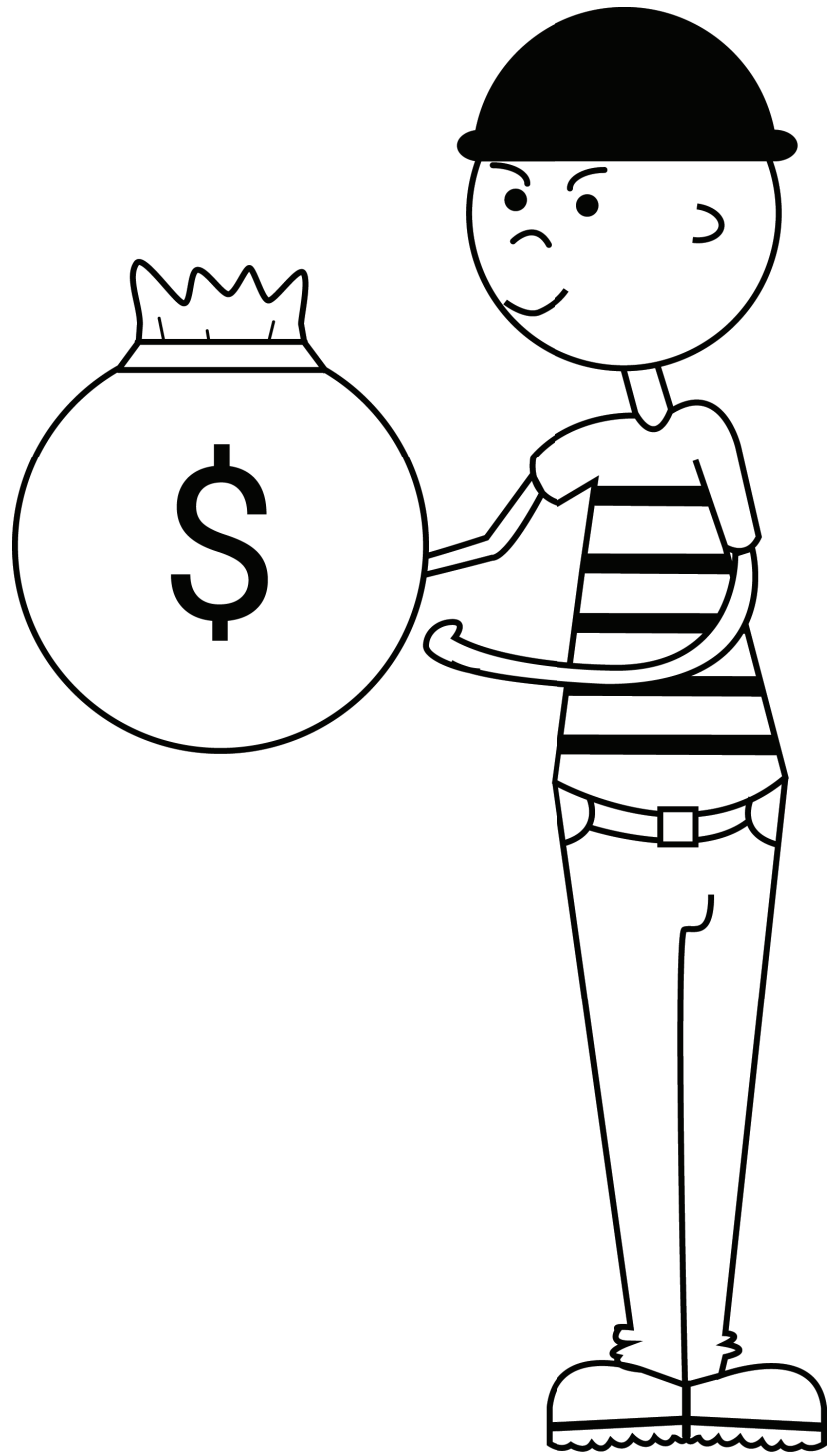

steal

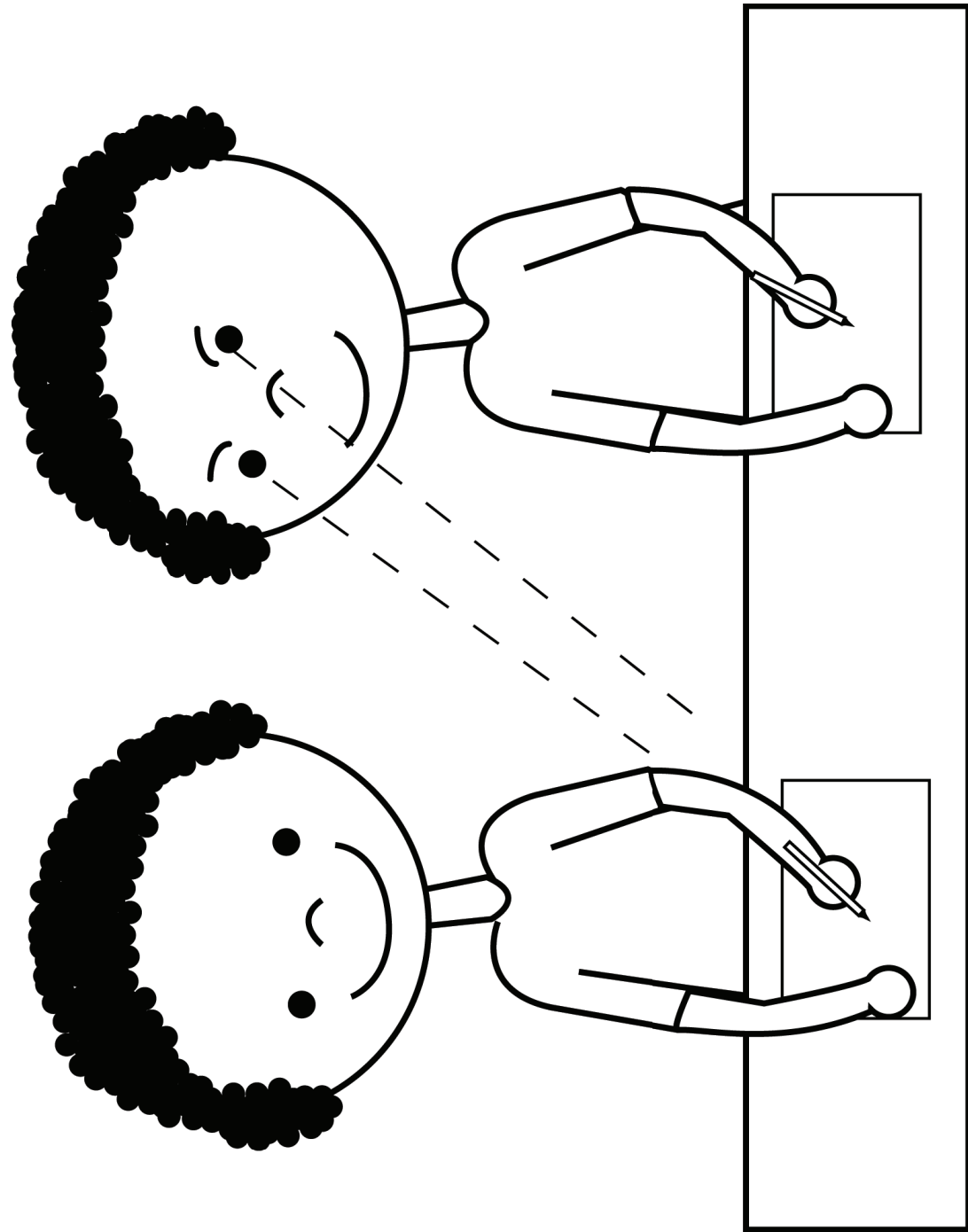

cheat

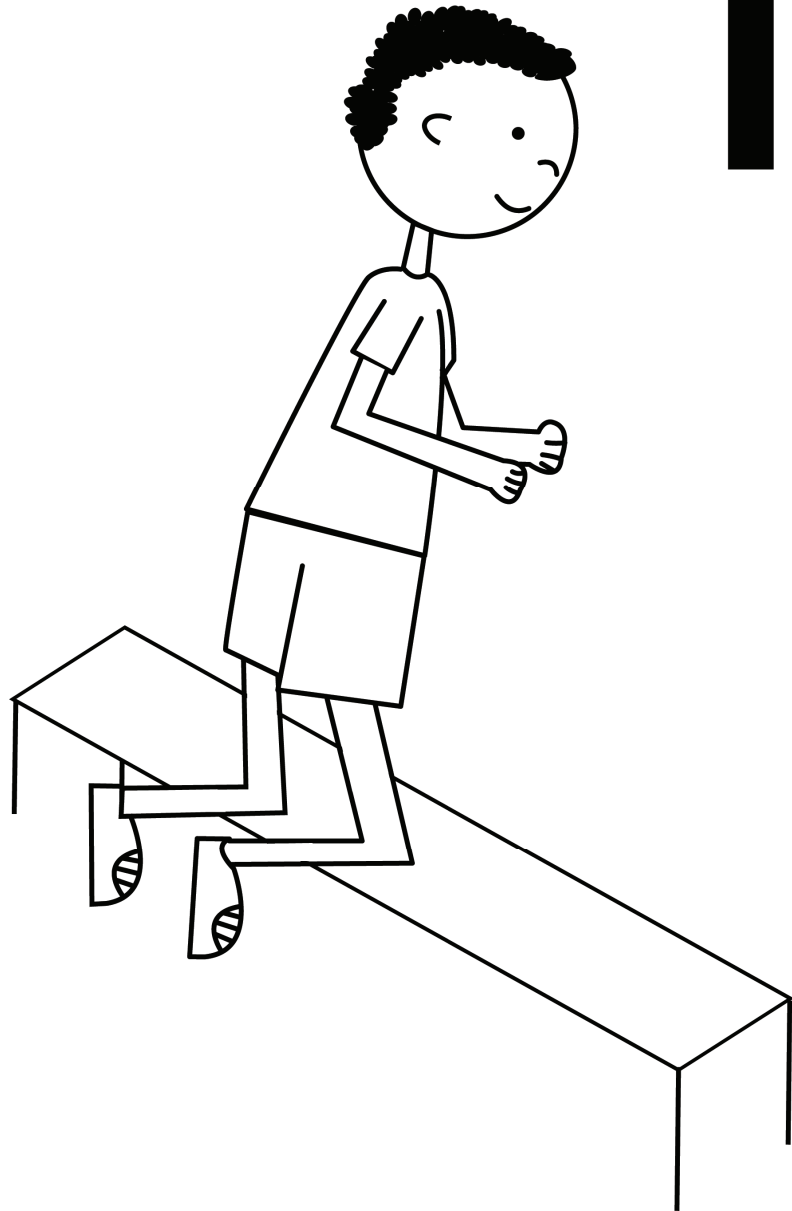

kneel

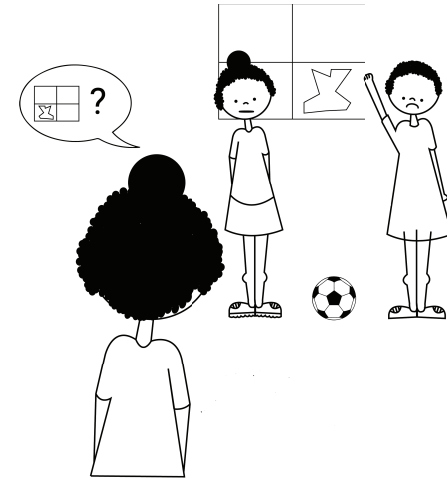

admit



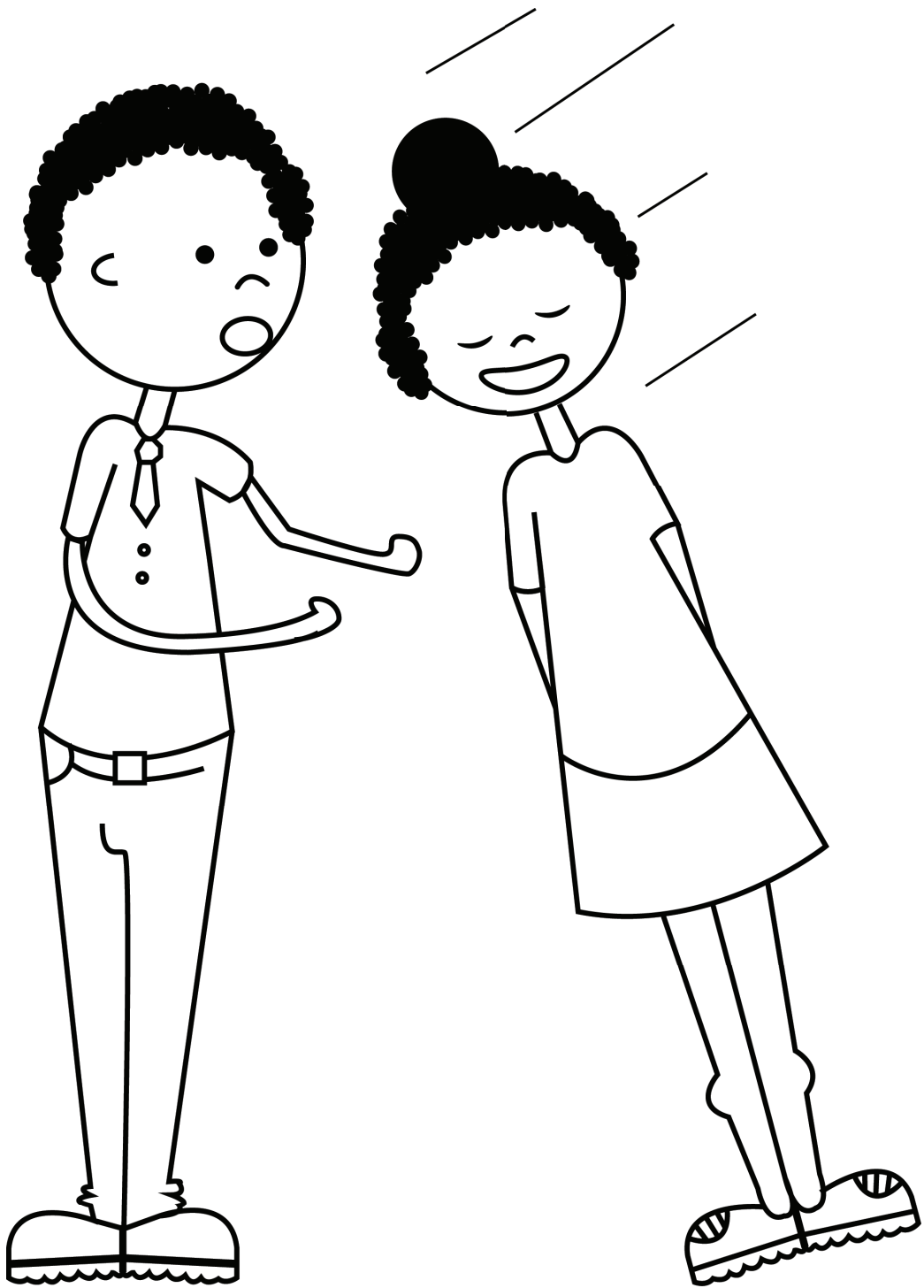

trust

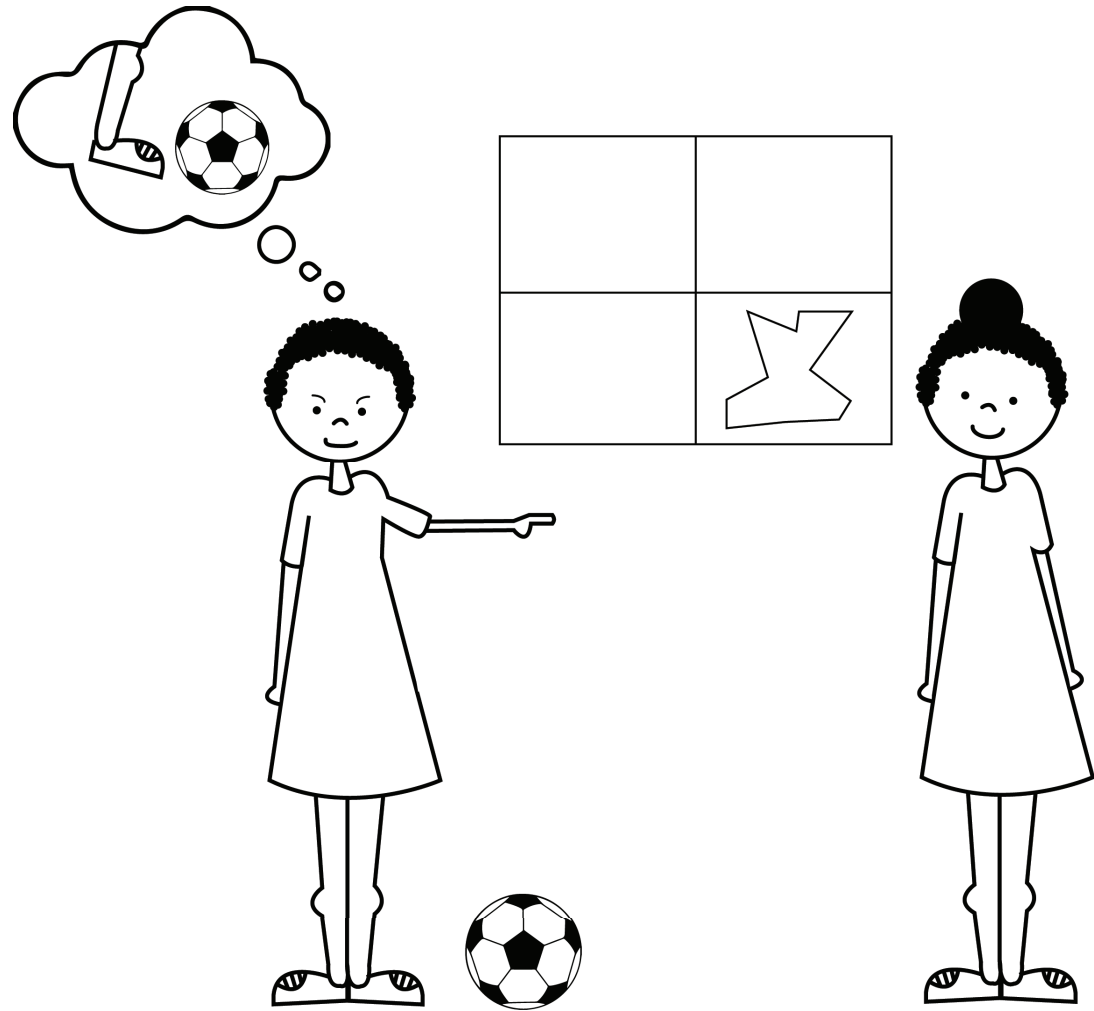

betray



guilty

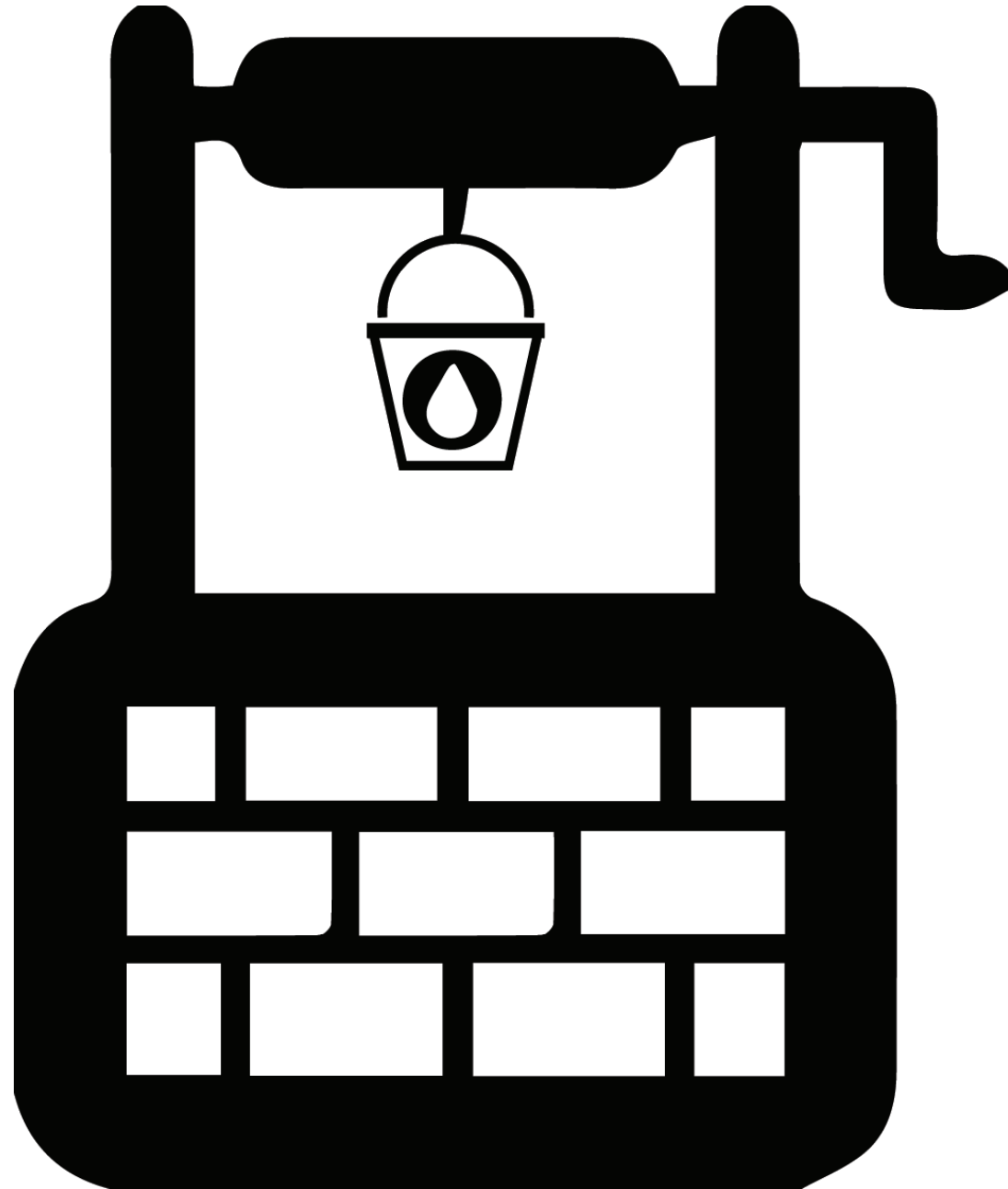

well

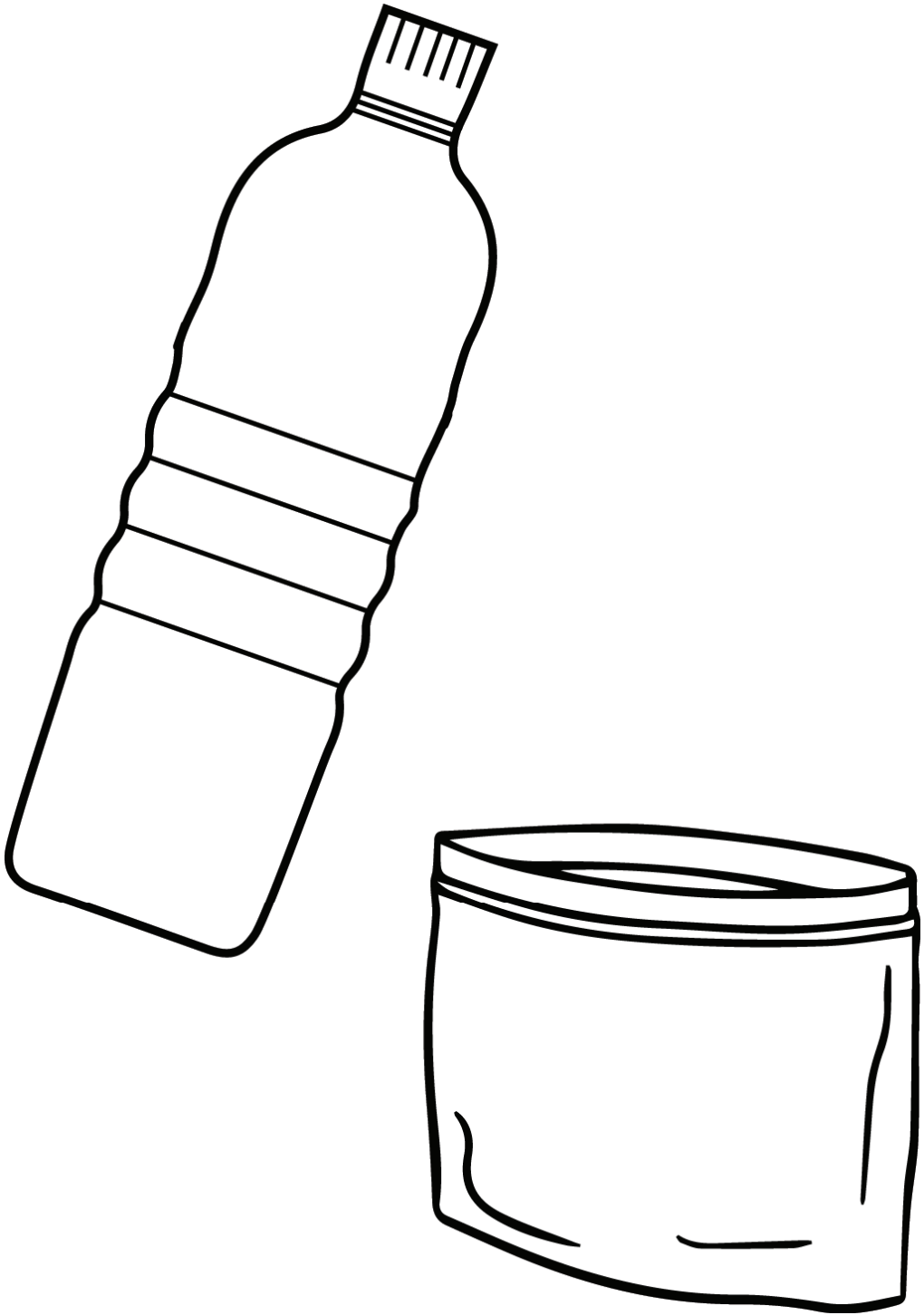

plastic

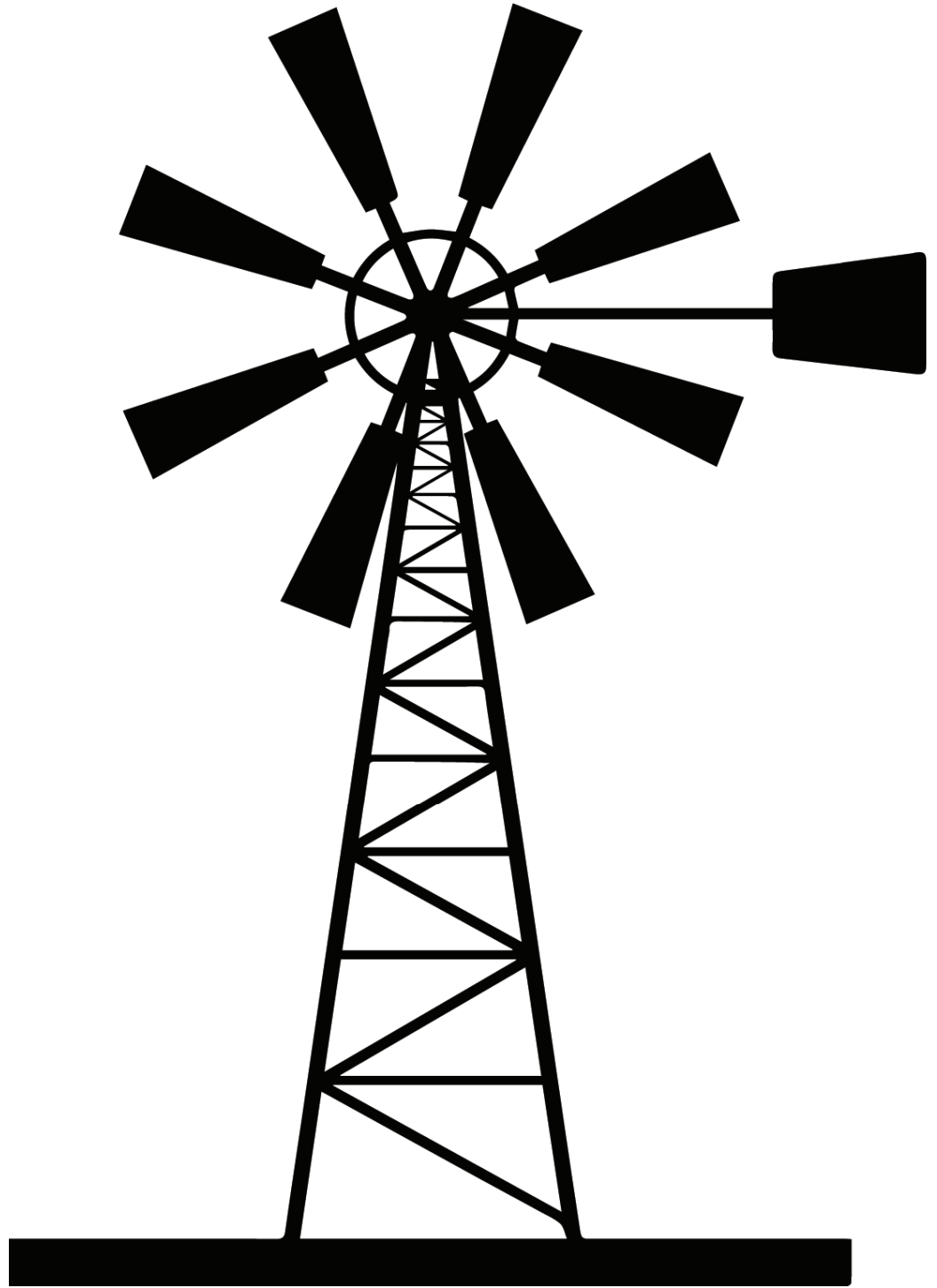

windmill

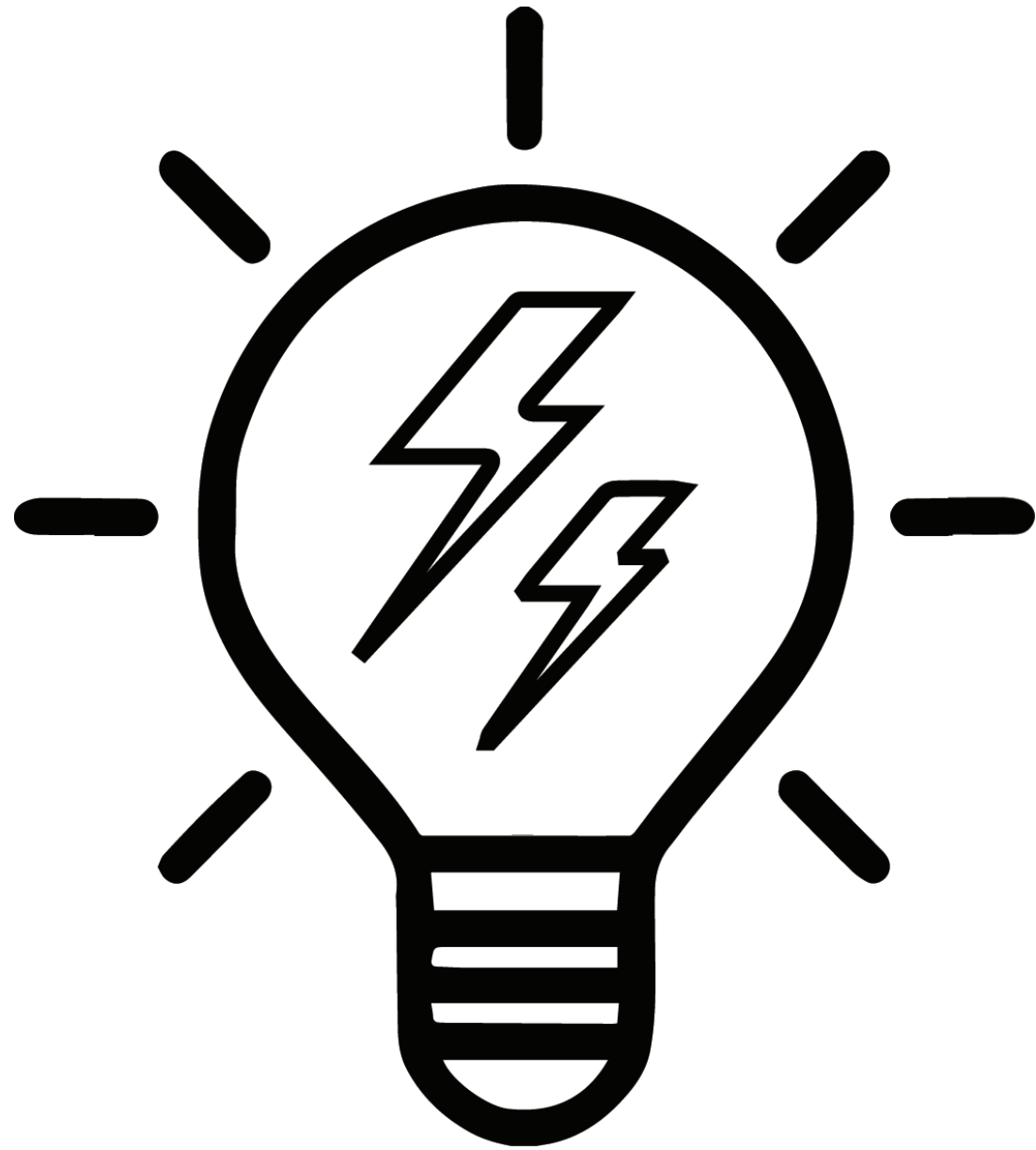

electricity

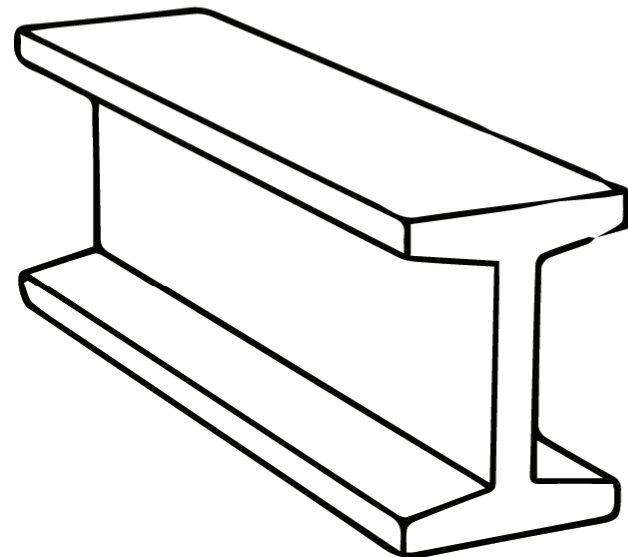
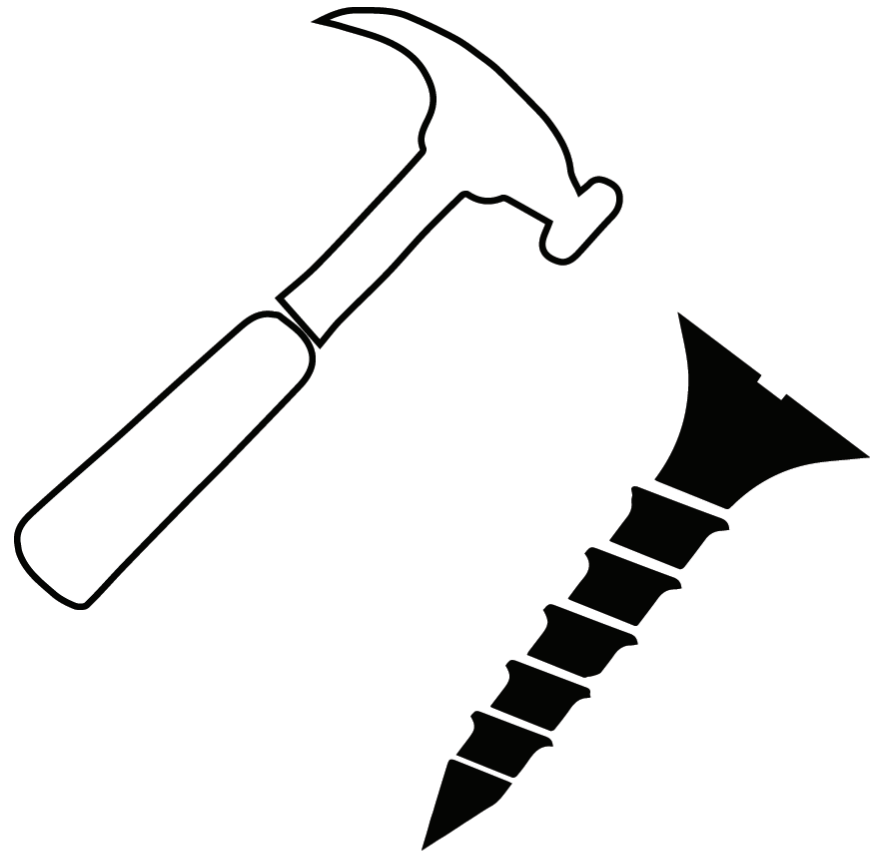

metal



size

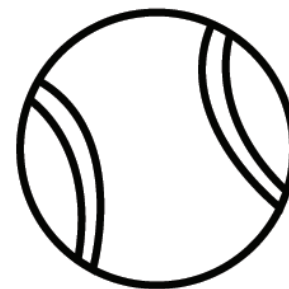
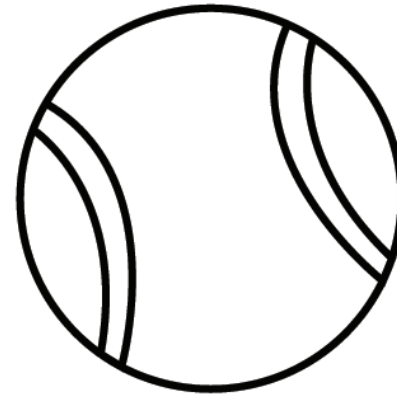
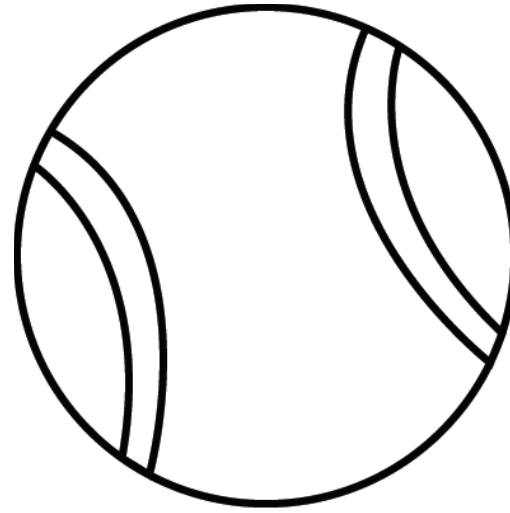

suffer

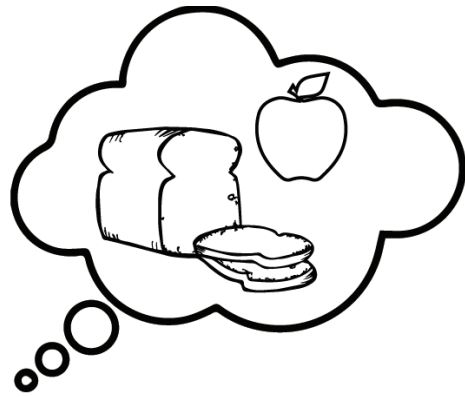
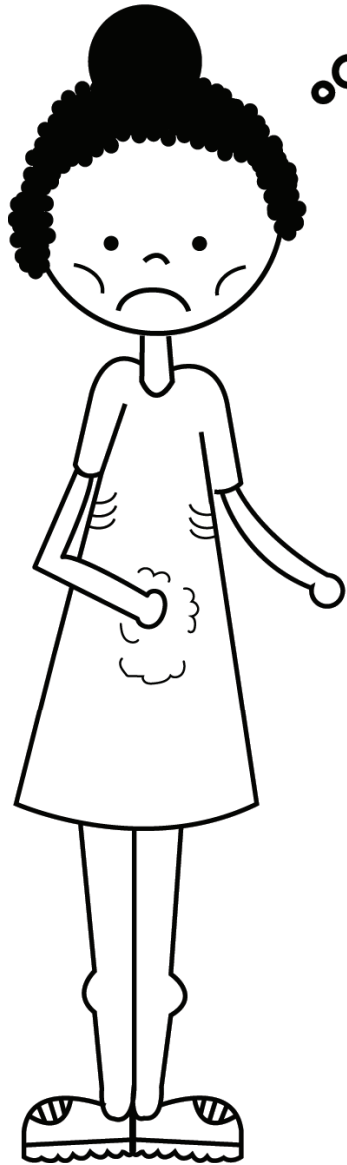

starve

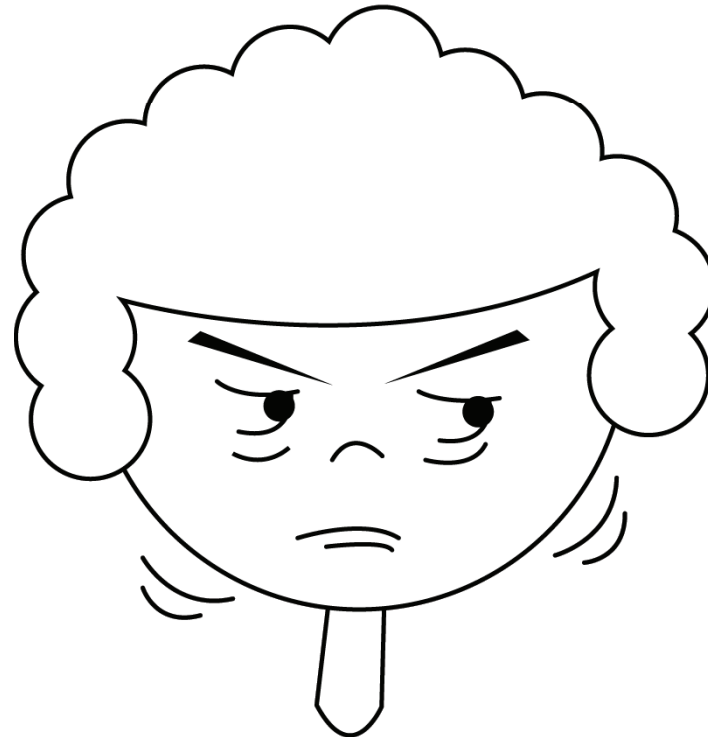

drop out

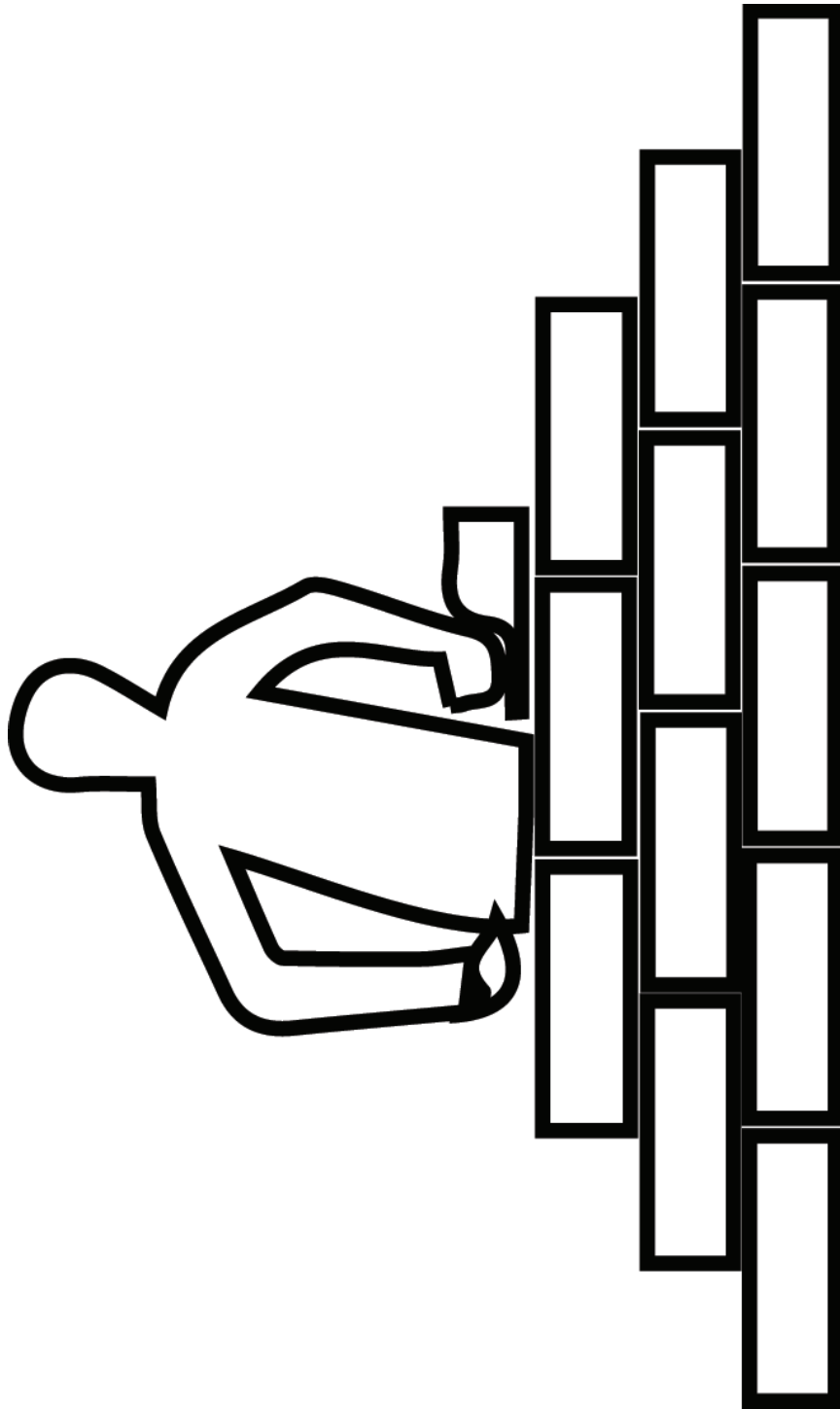

build

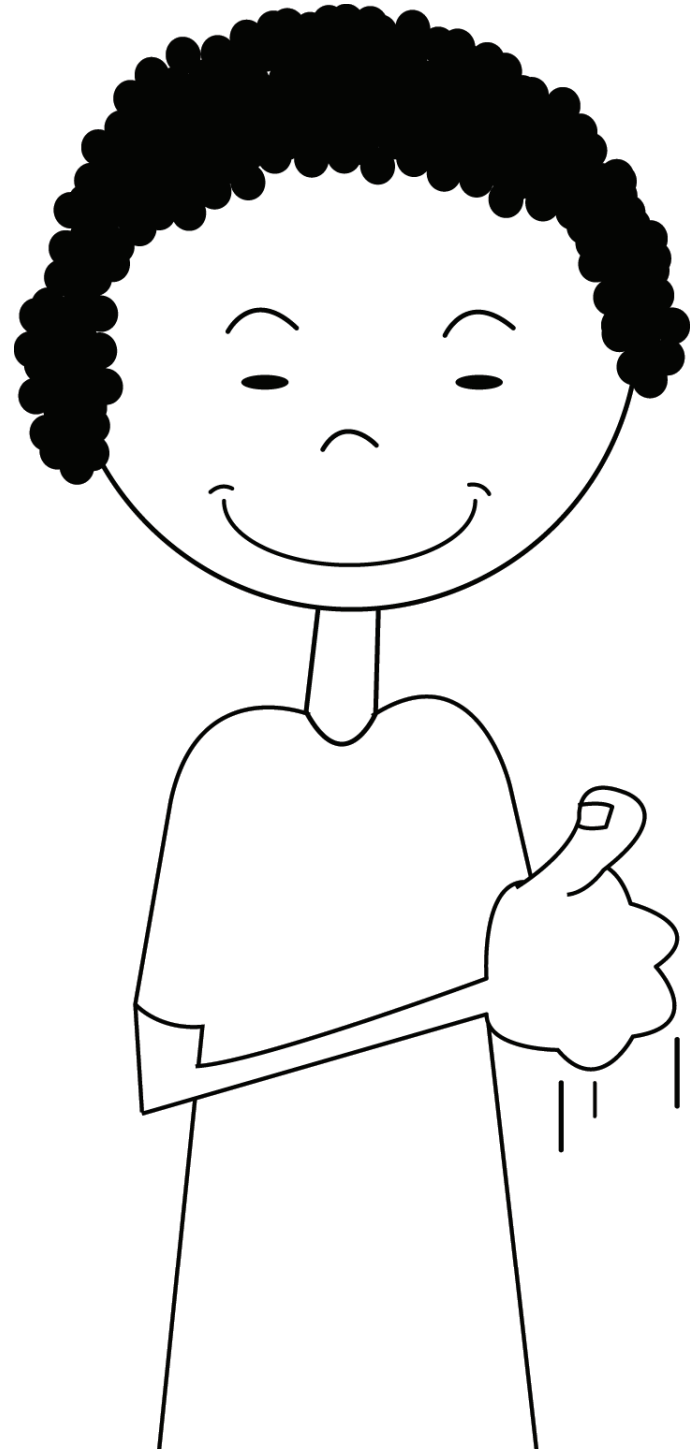

impressed

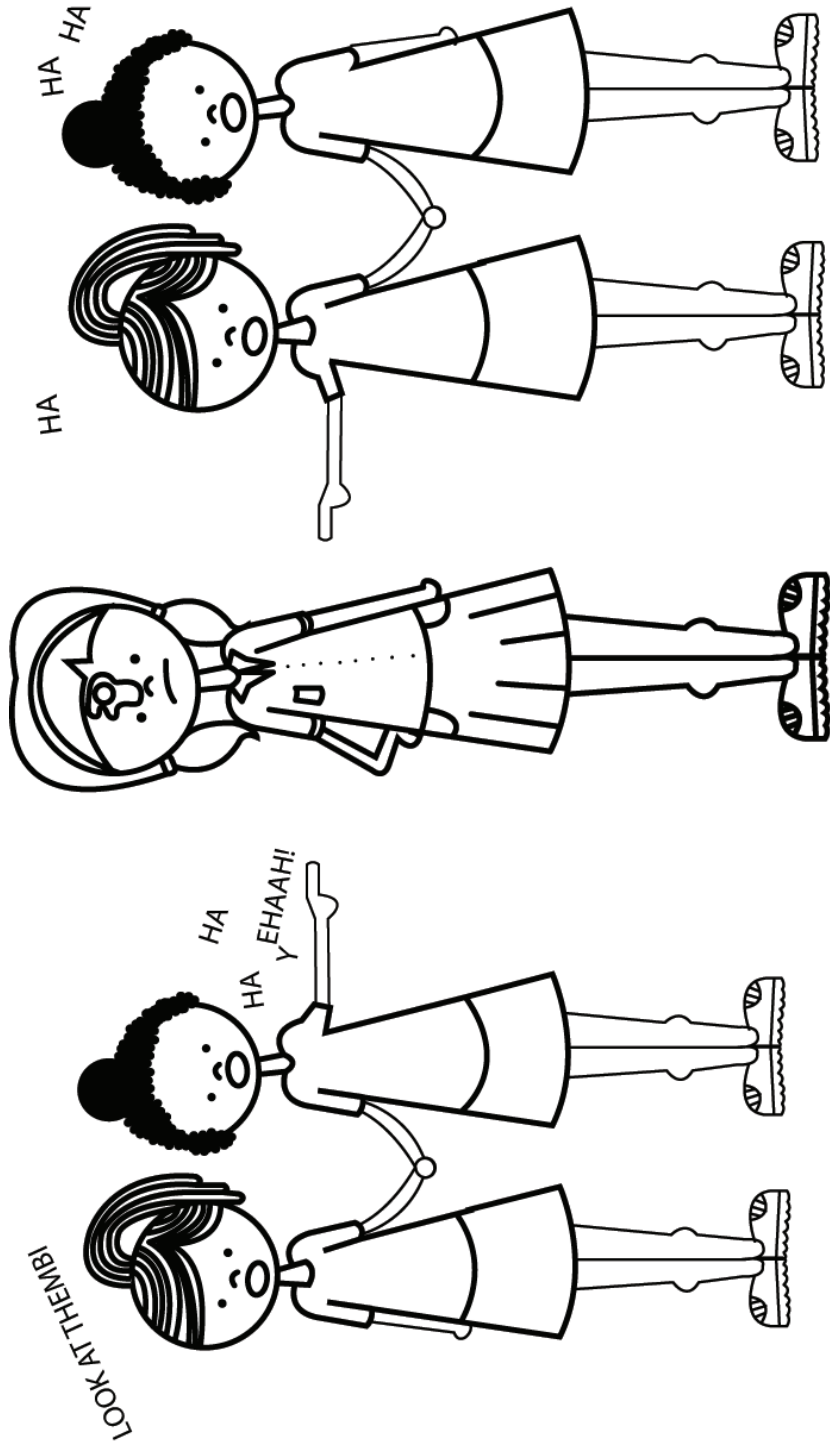

mocked



determined

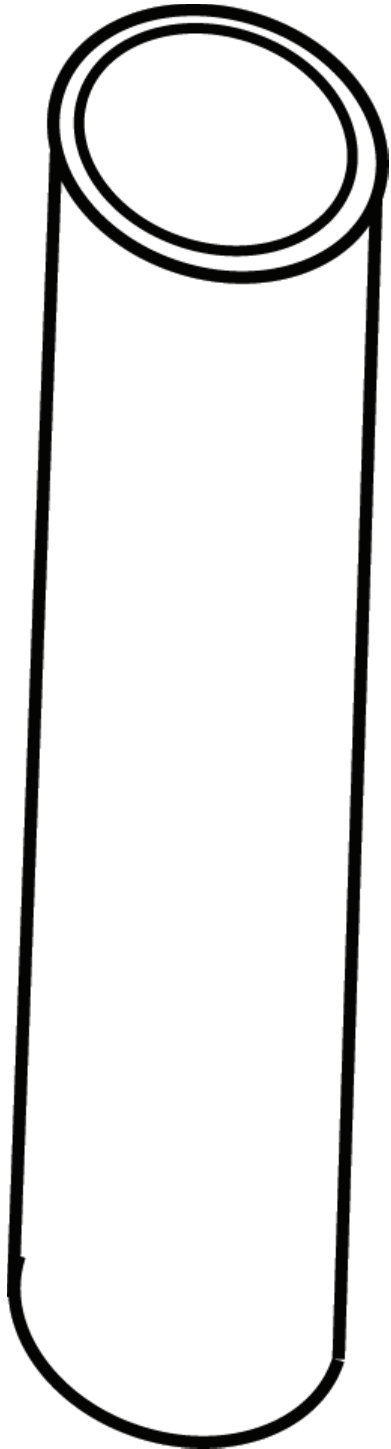

pipe

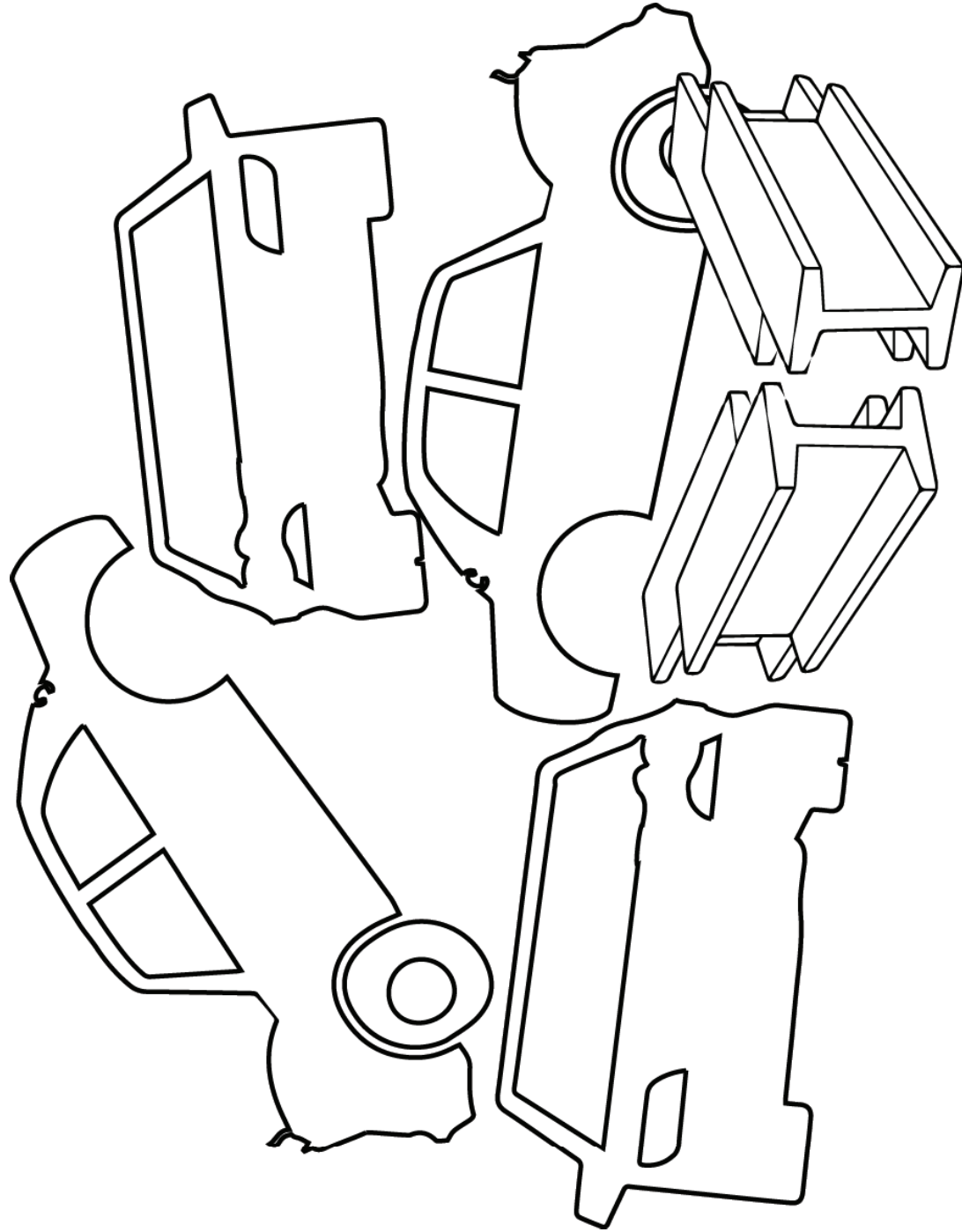

scrap yard

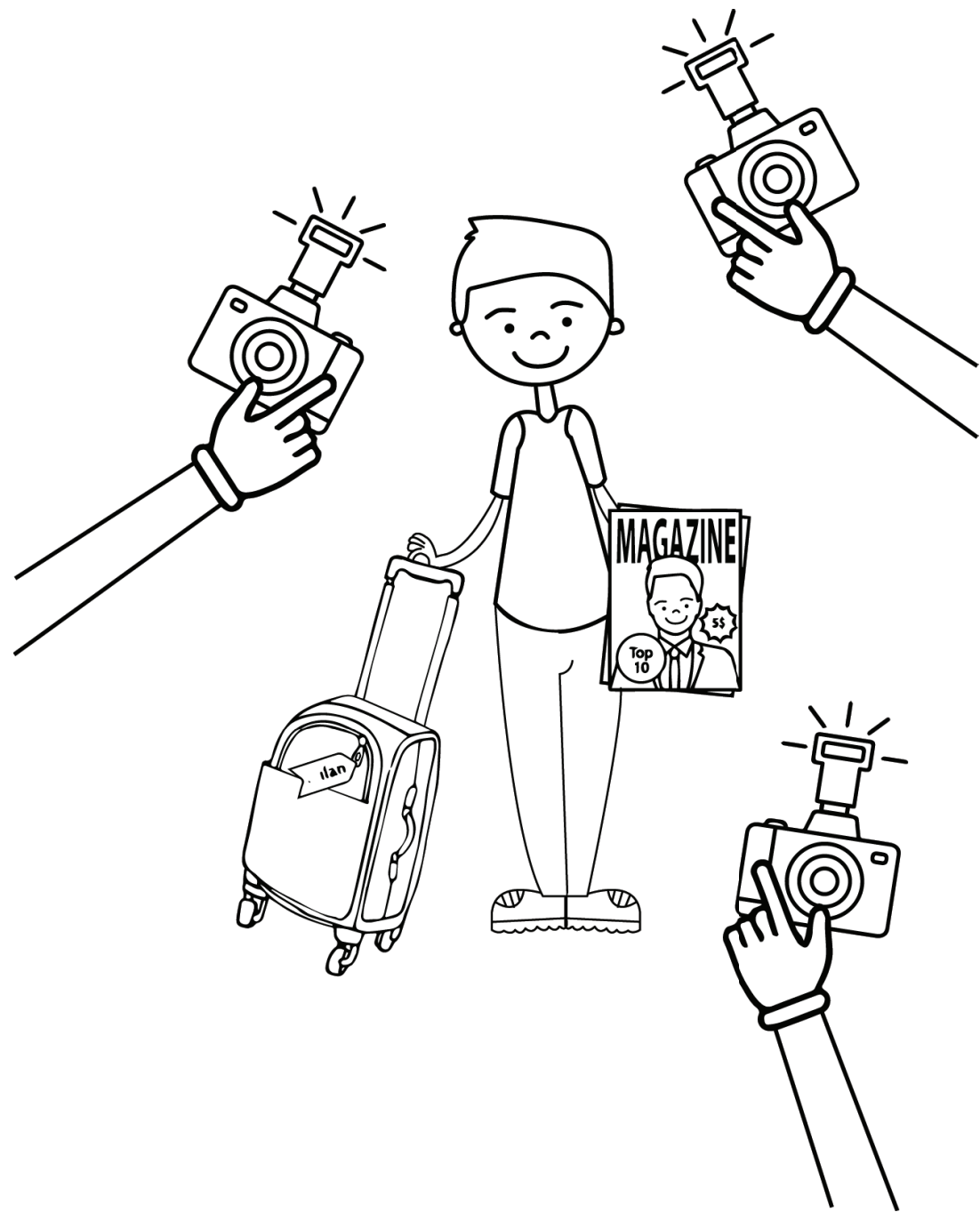

famous

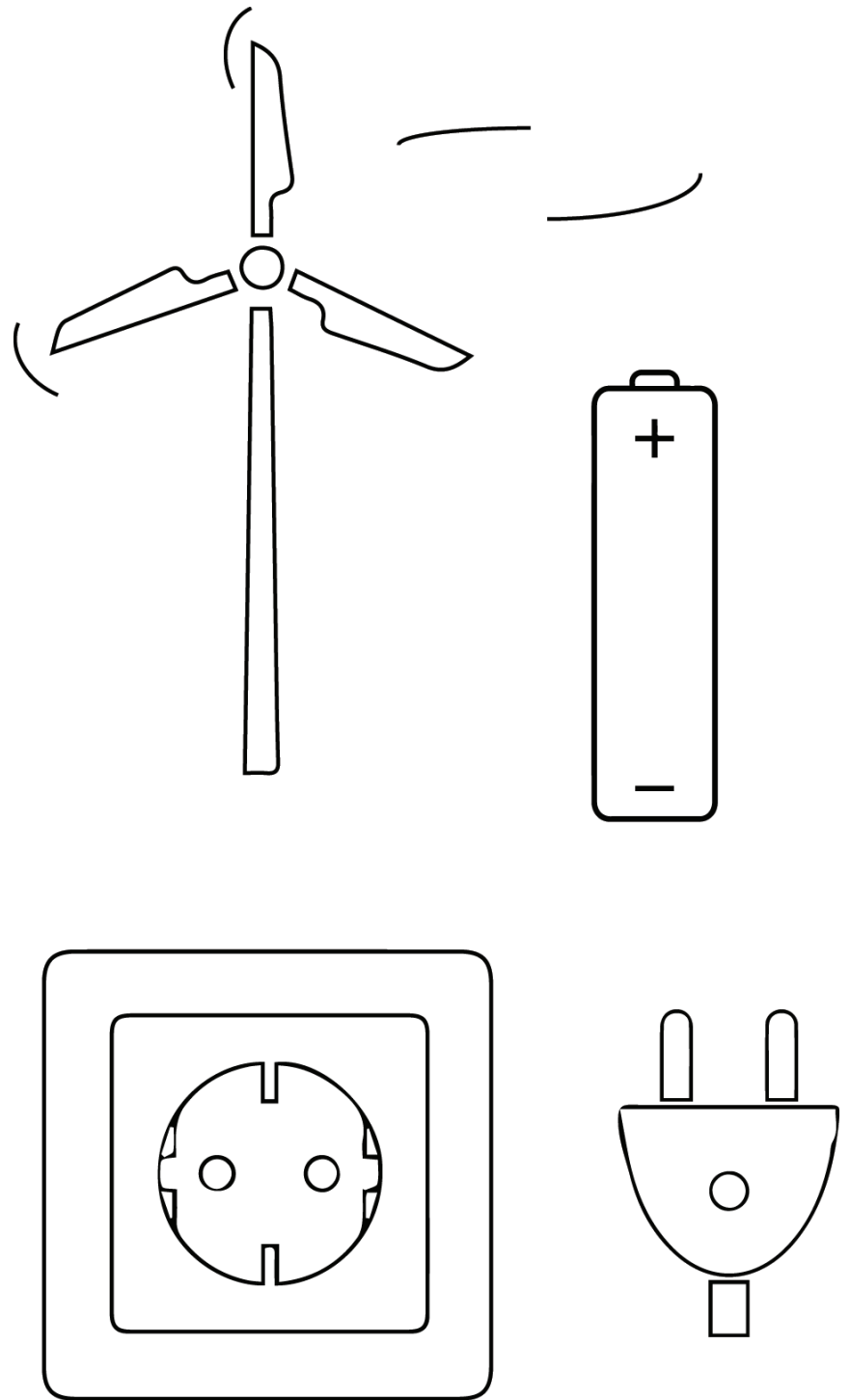

energy

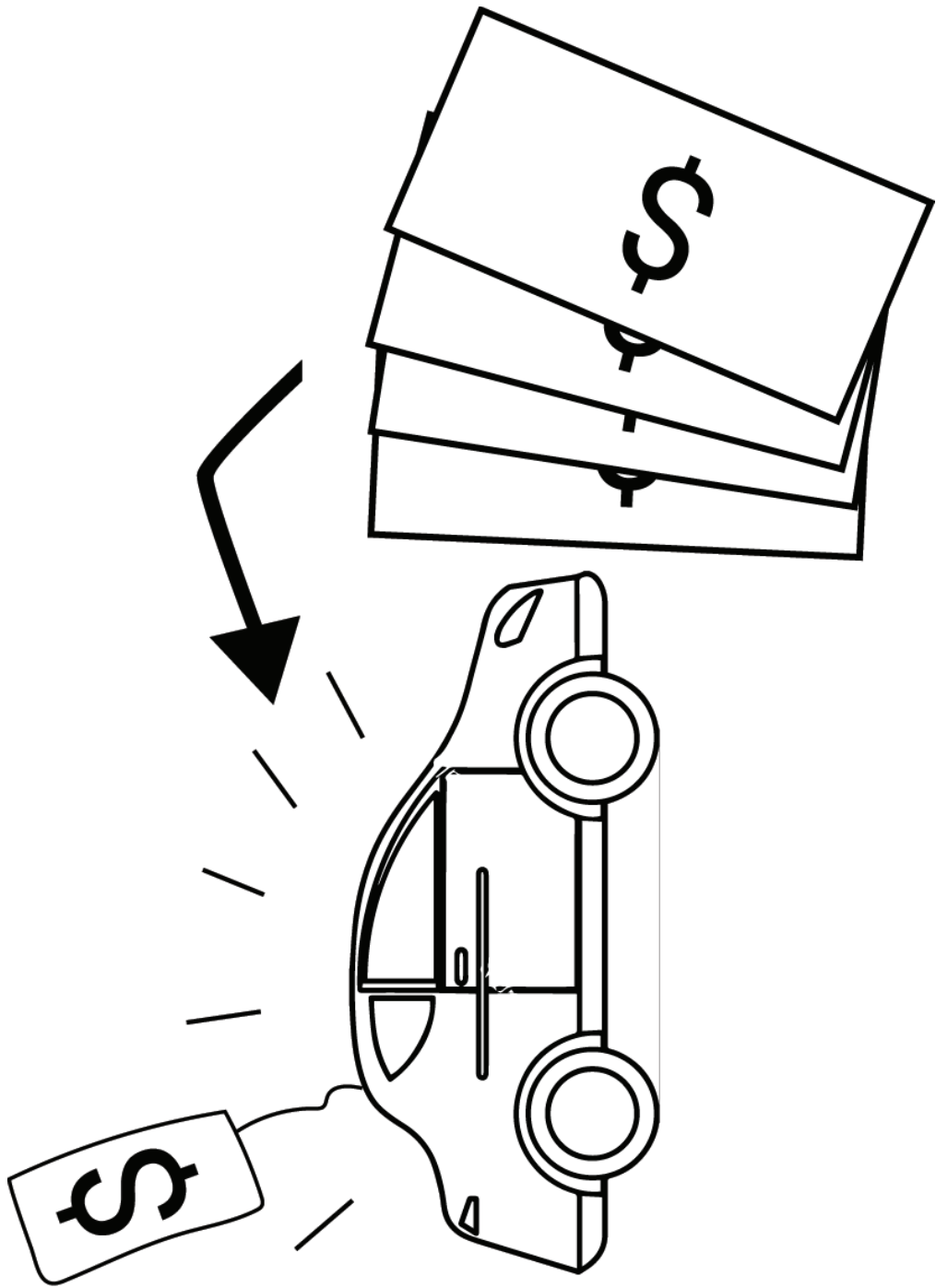

afford

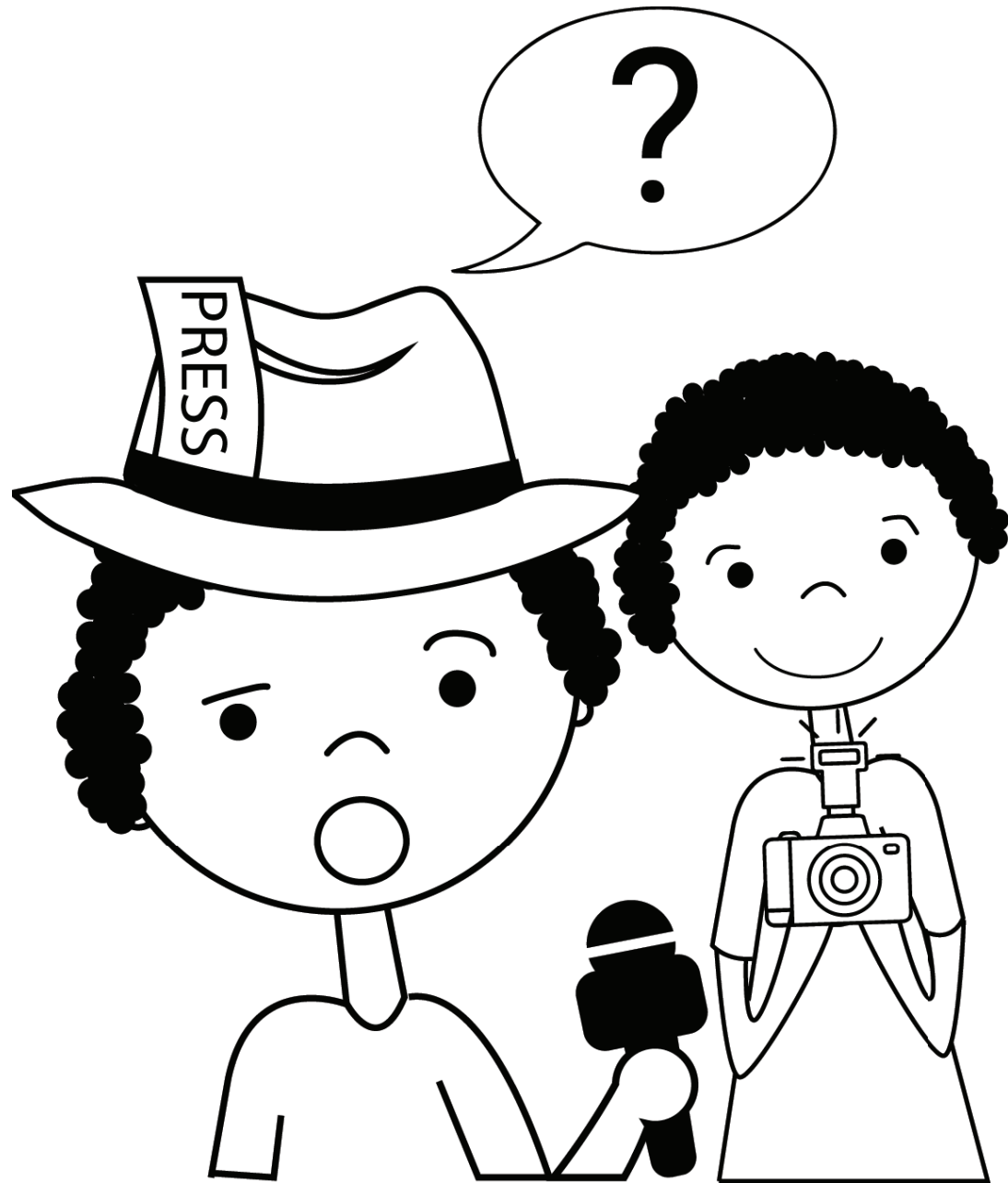

journalist

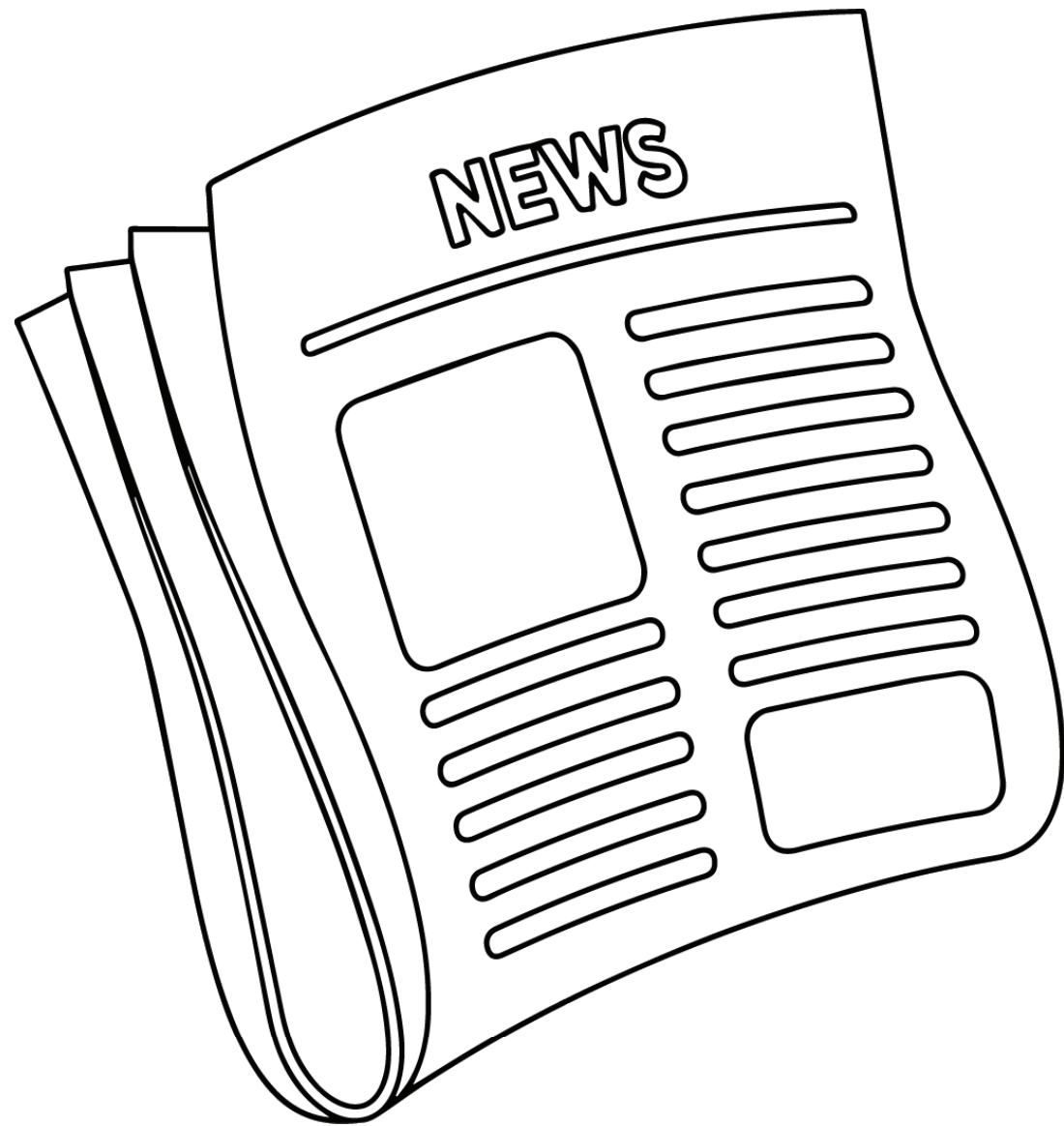

hang out

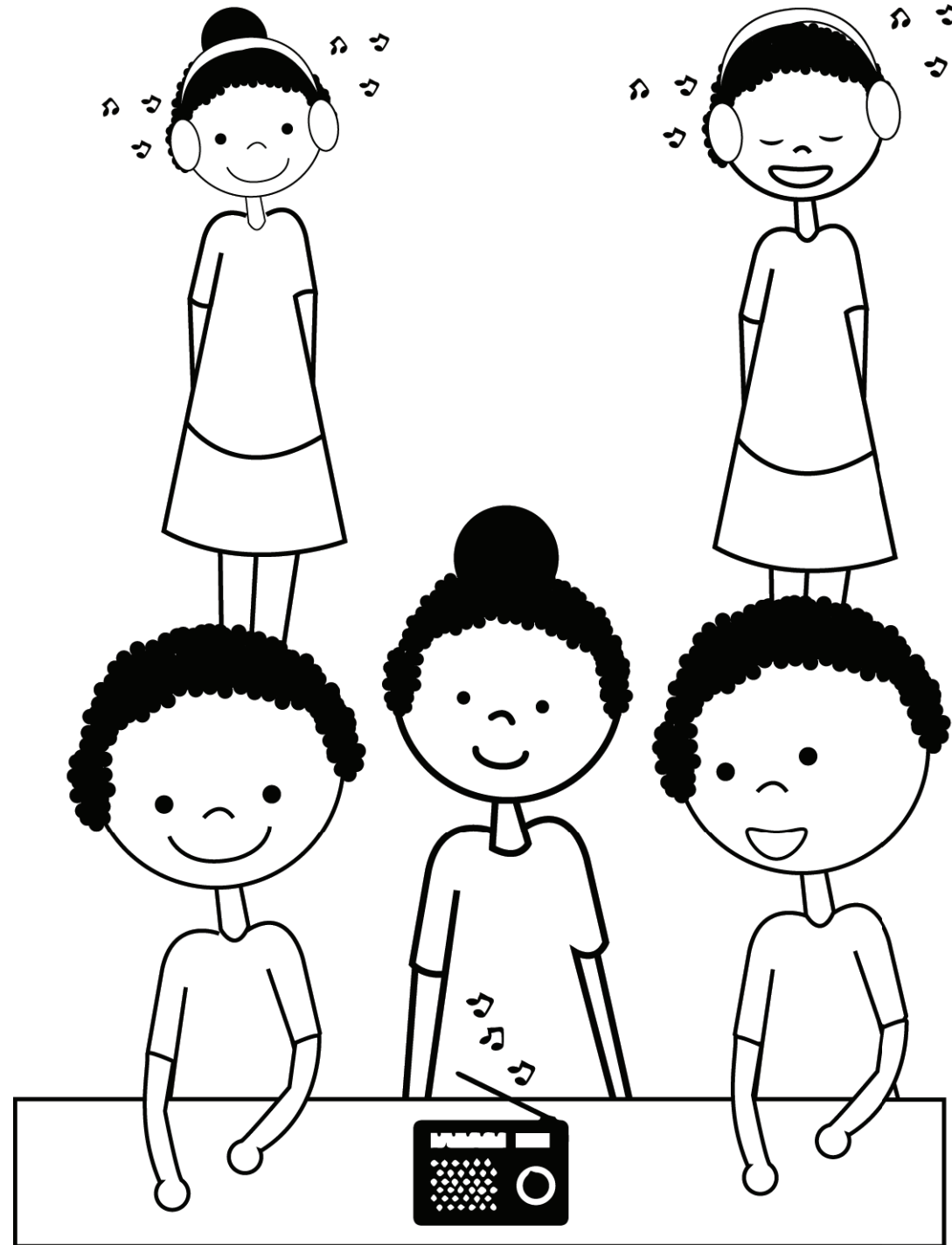

article



radio

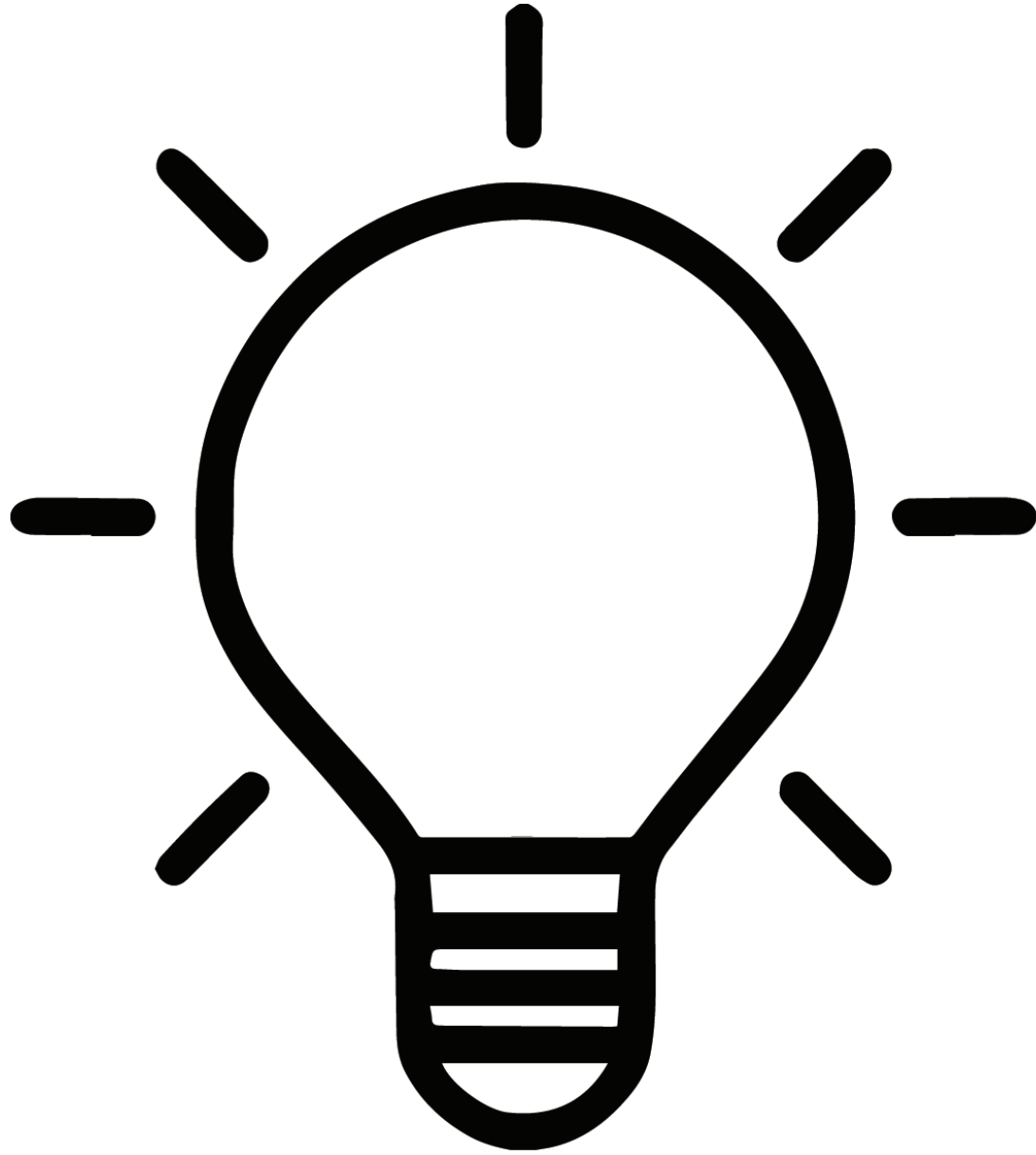

lightbulb

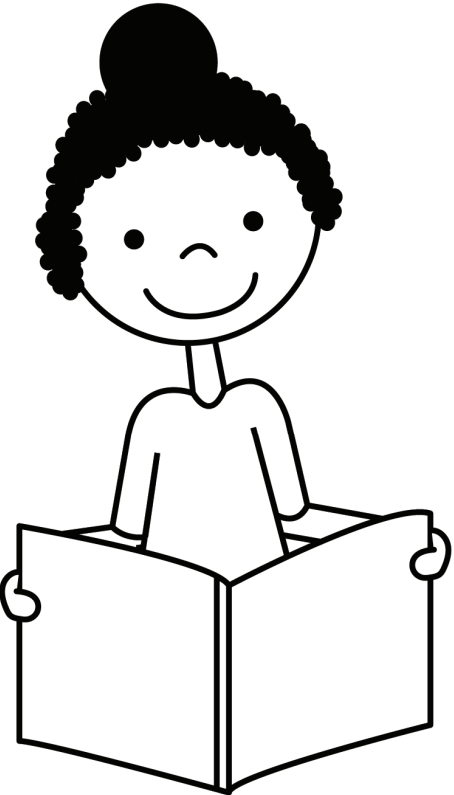
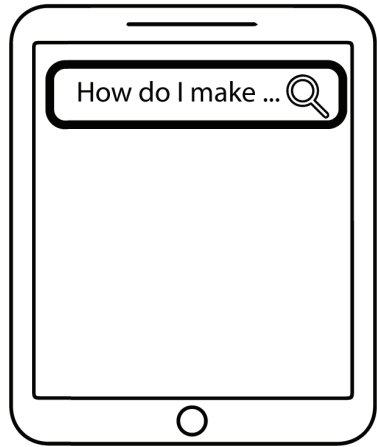
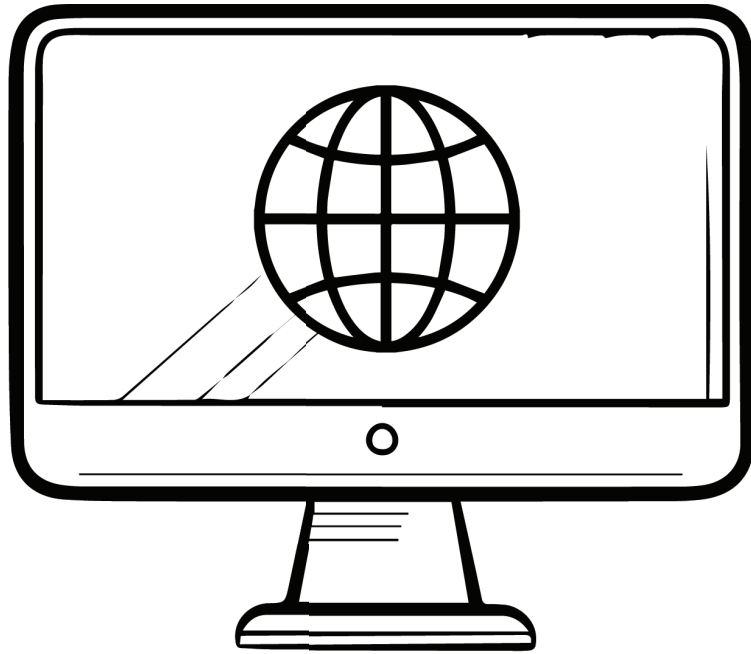
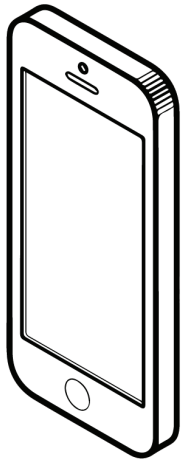

resources

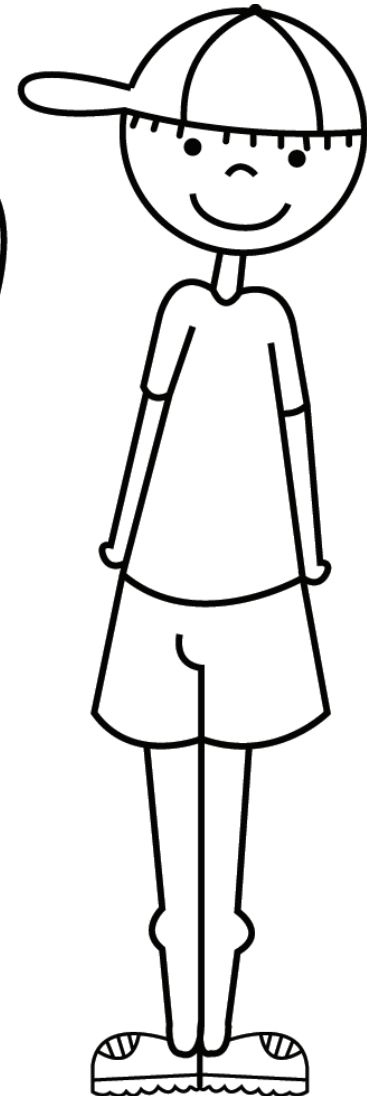
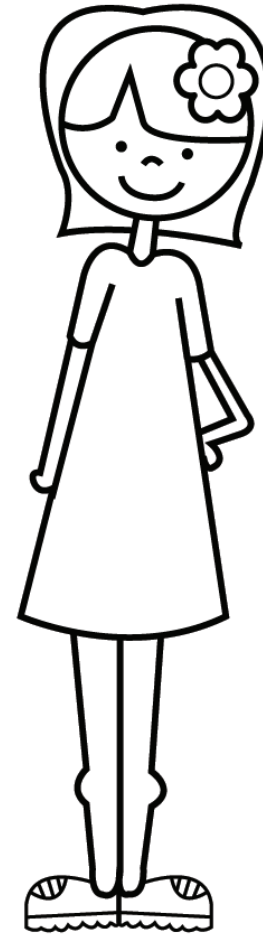
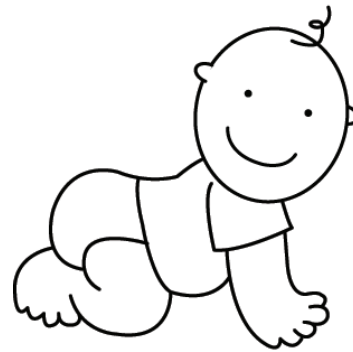

children

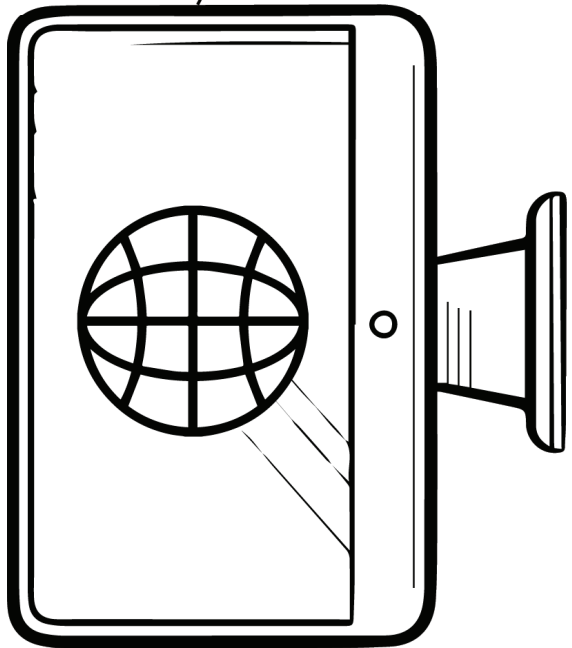
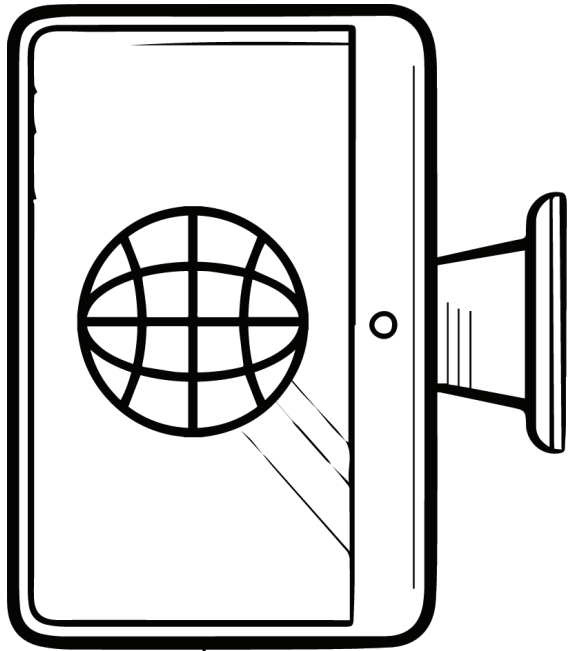

internet

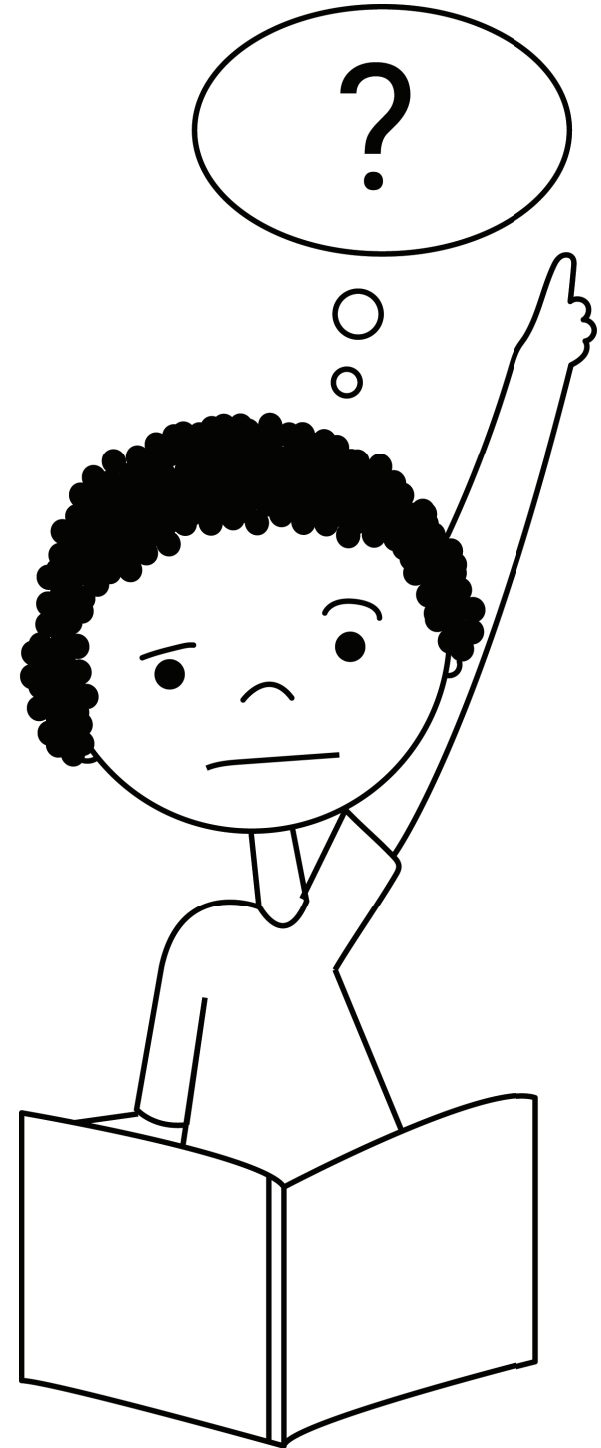

question

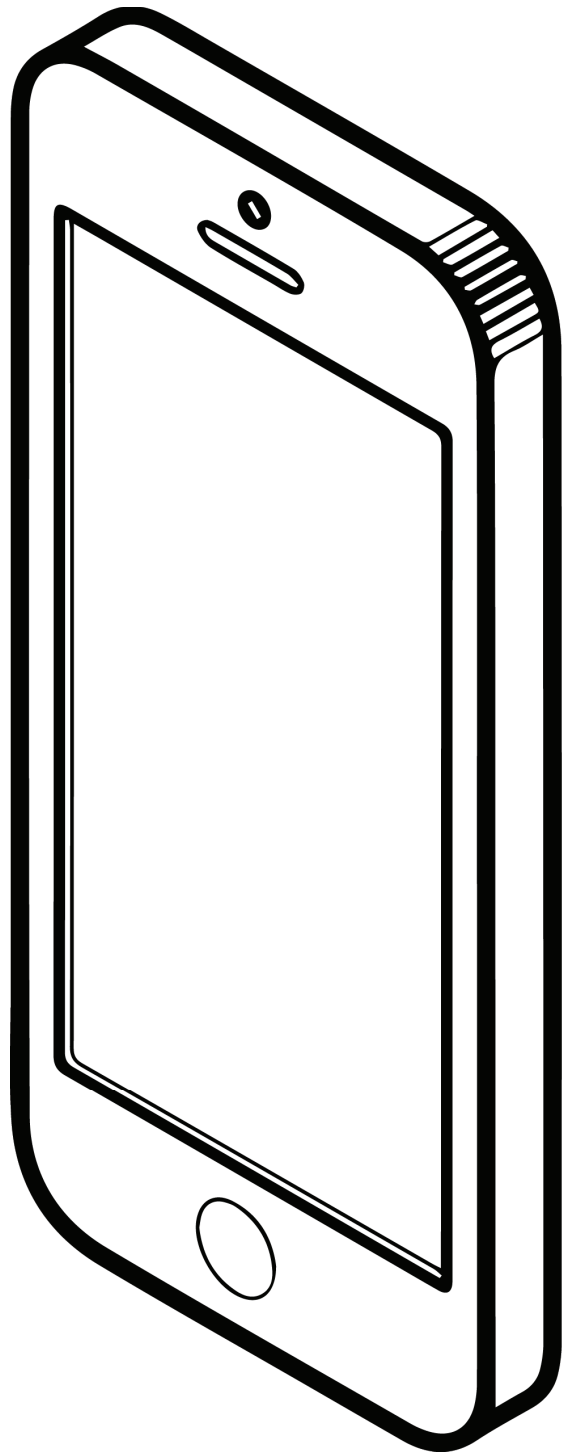

phone

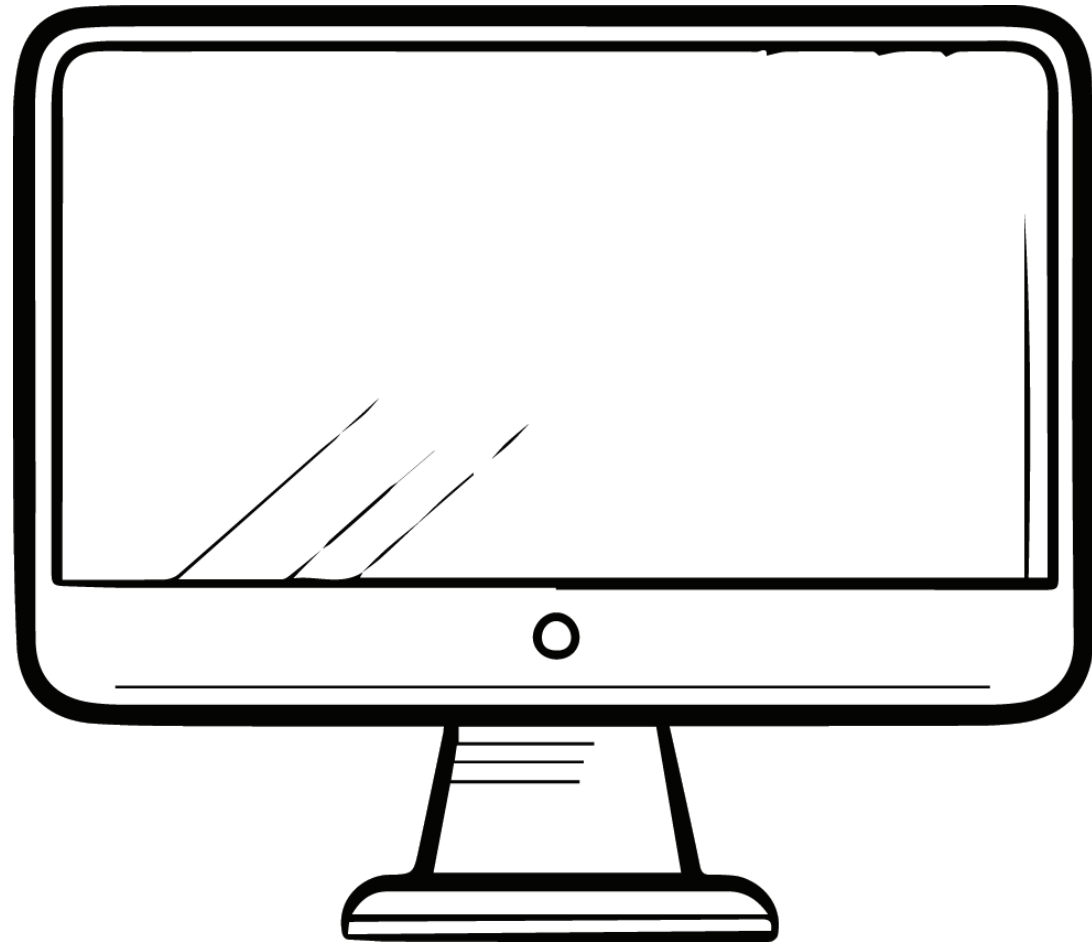

computer

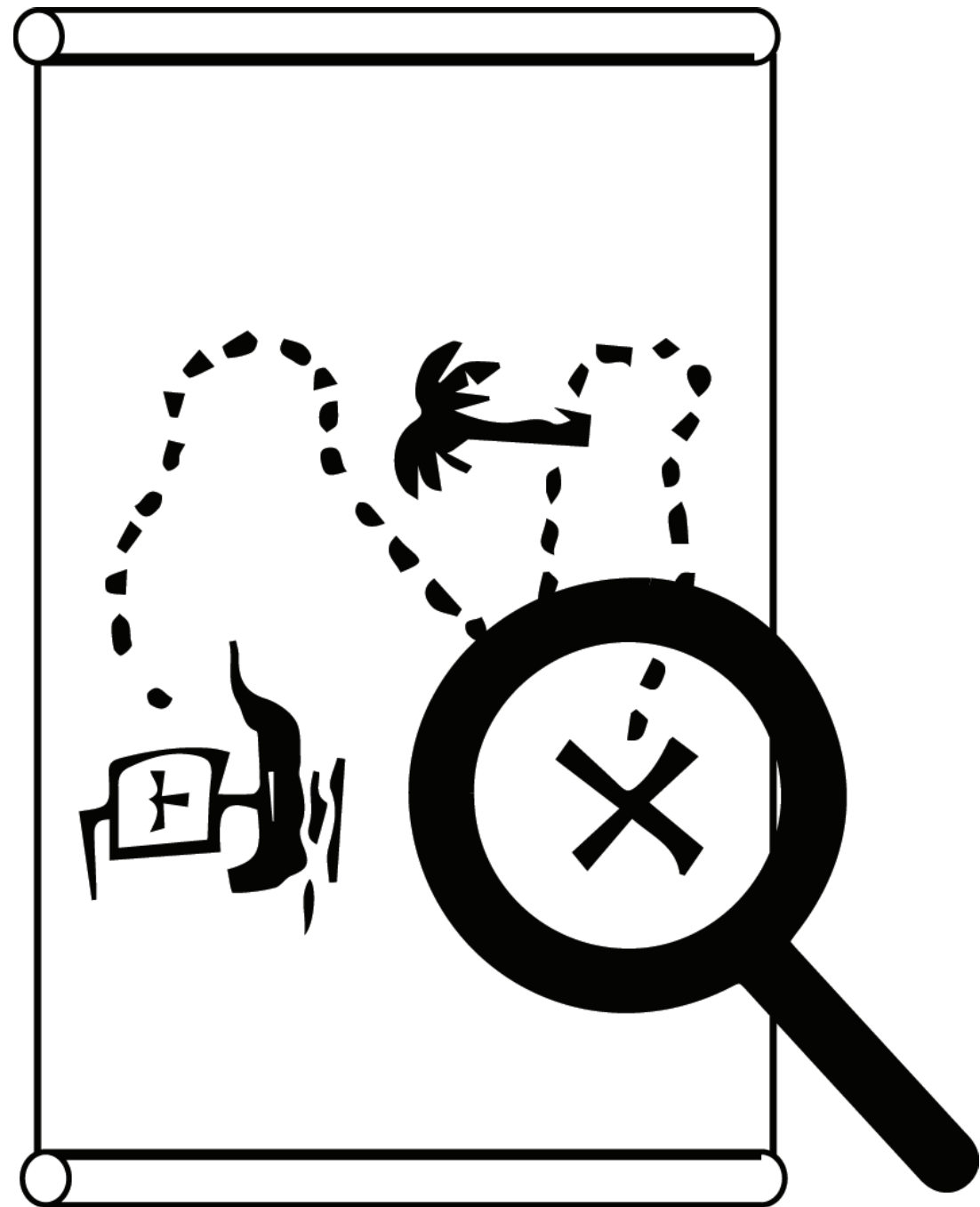

search

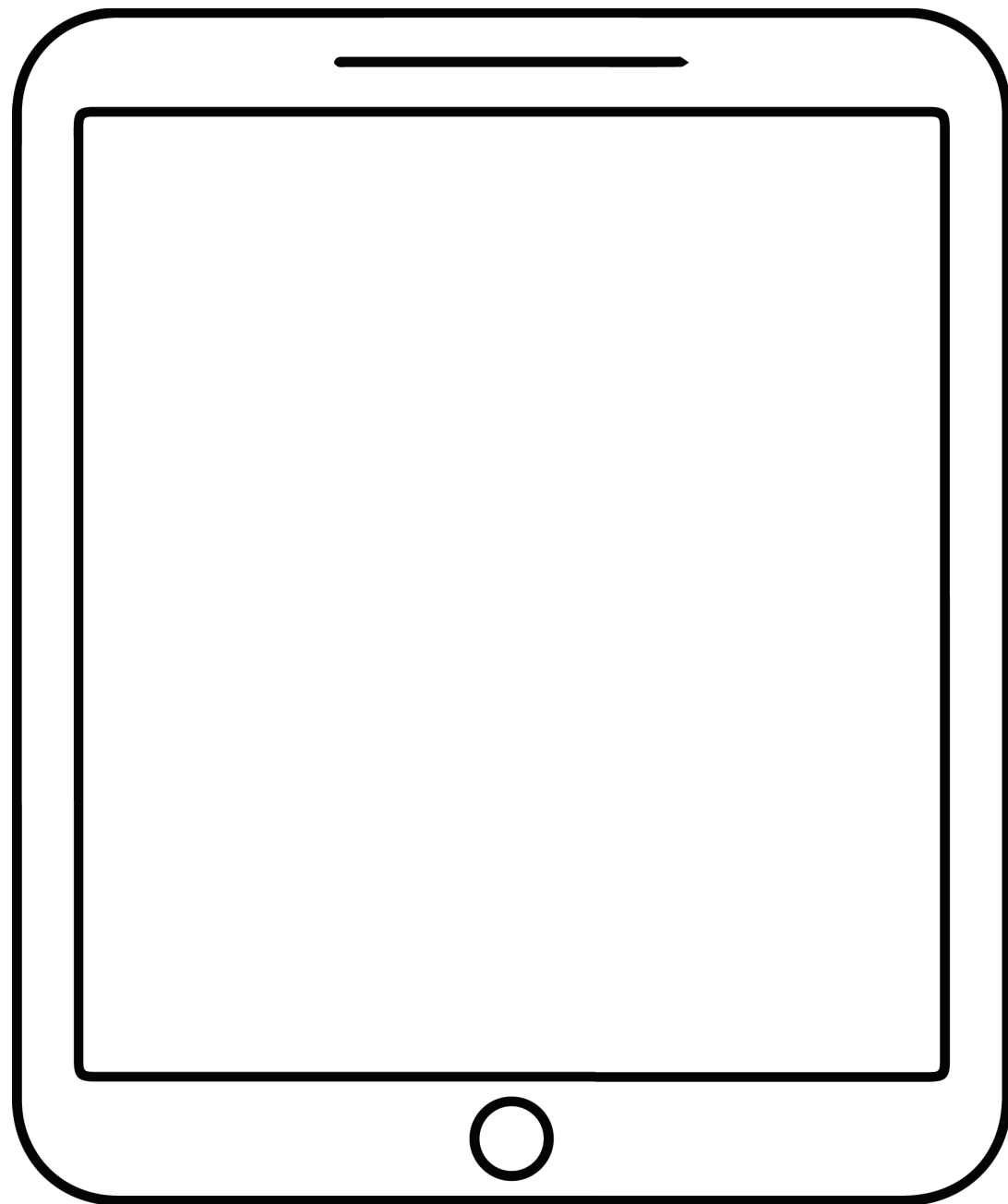

tablet

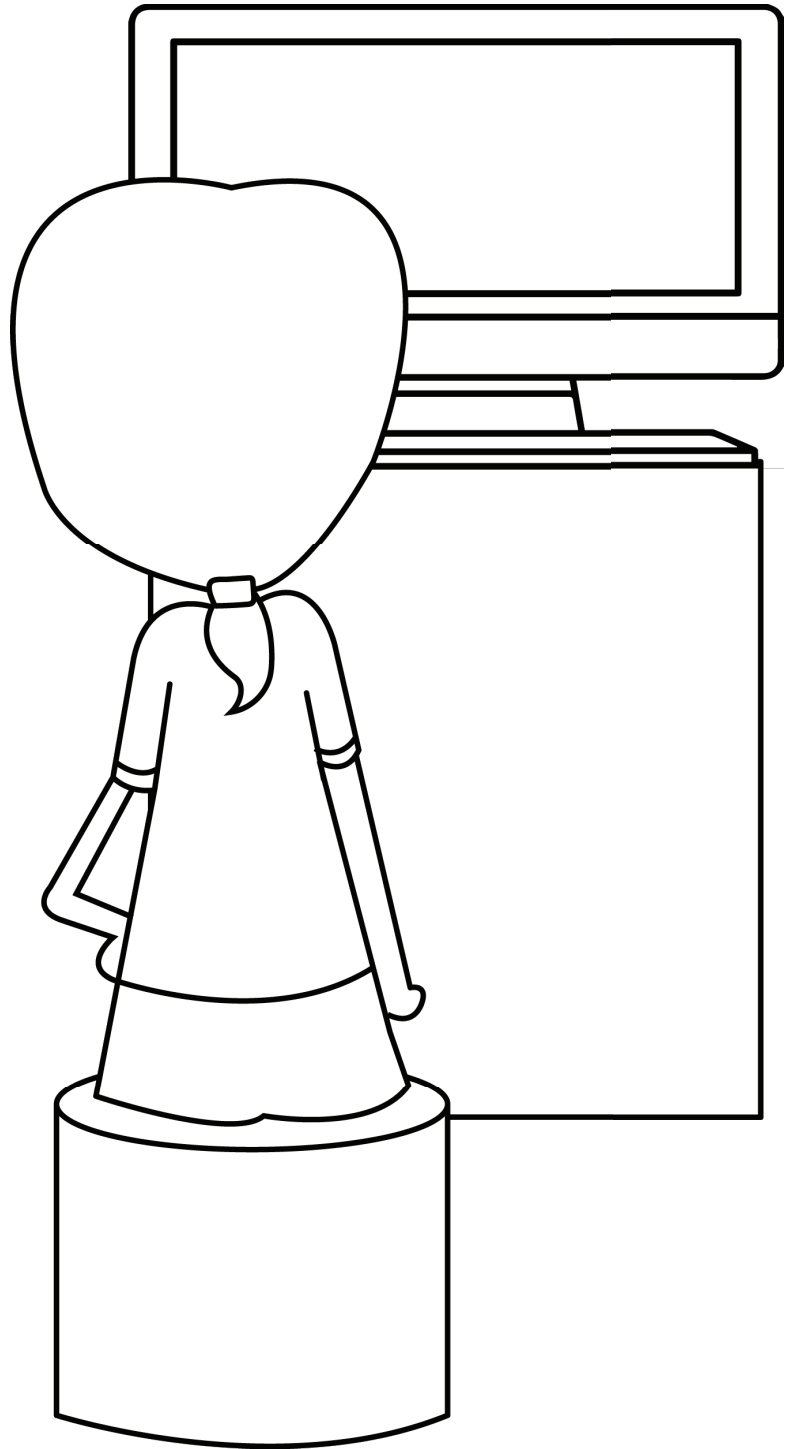

watch

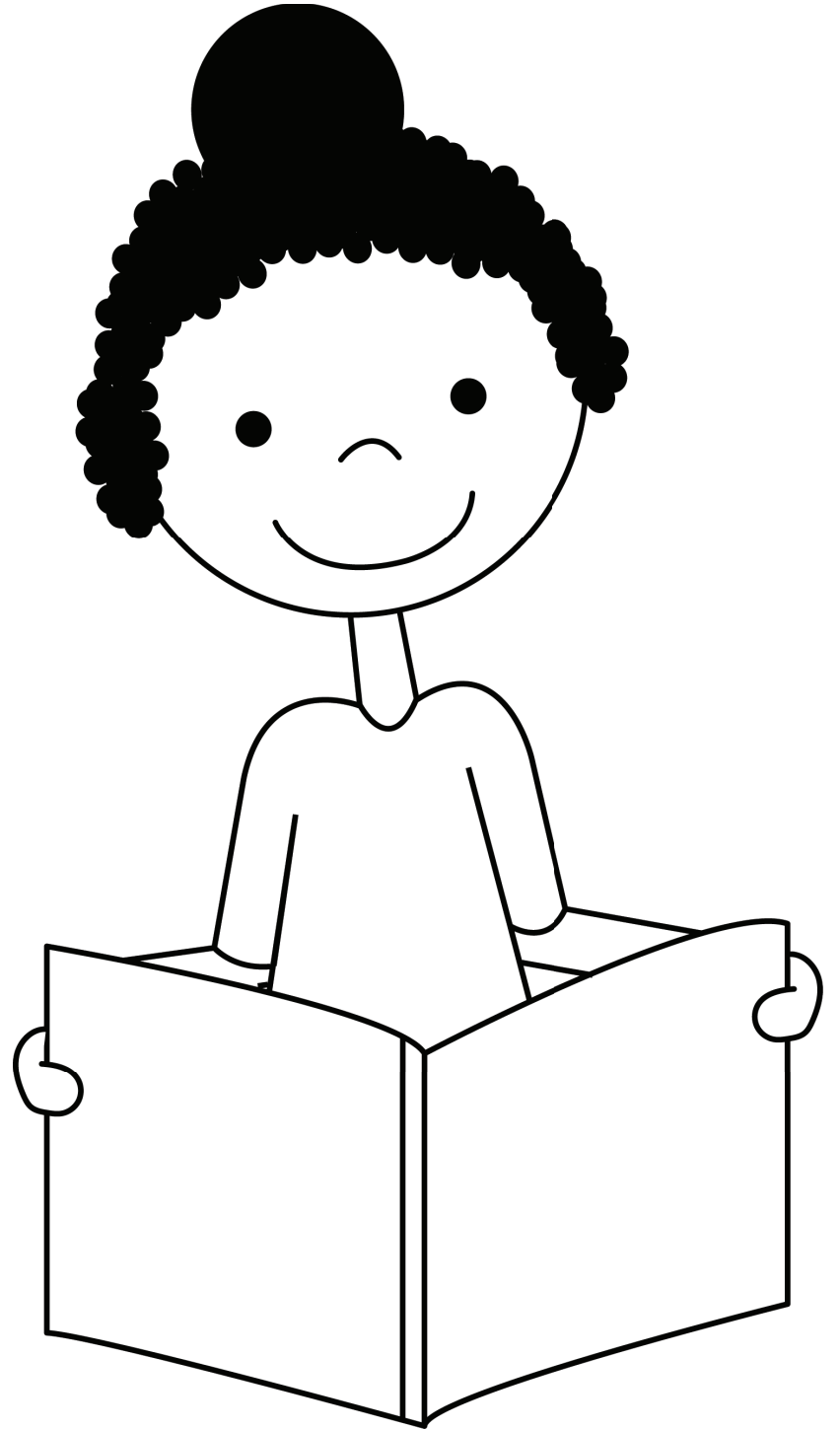

read

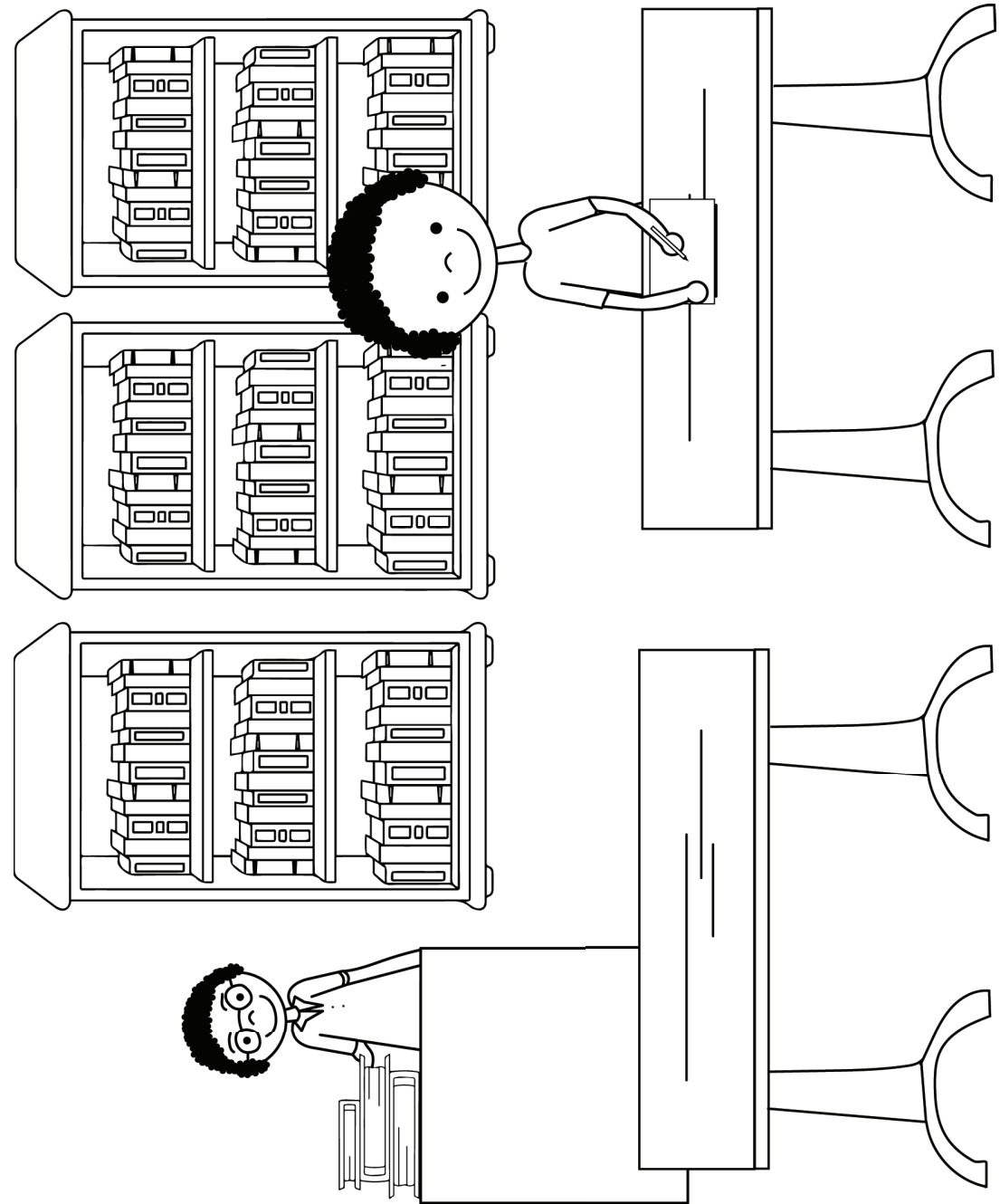

library

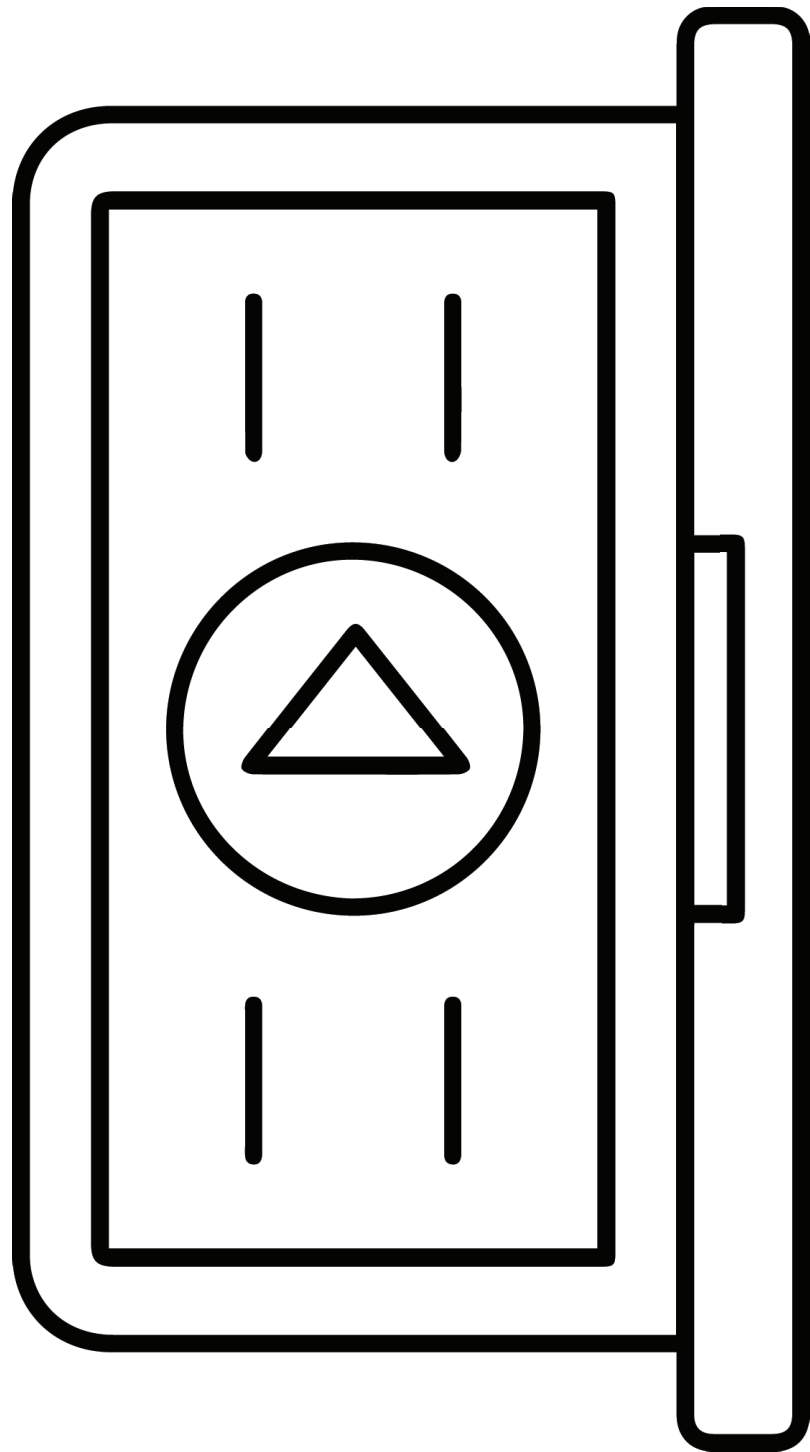

video

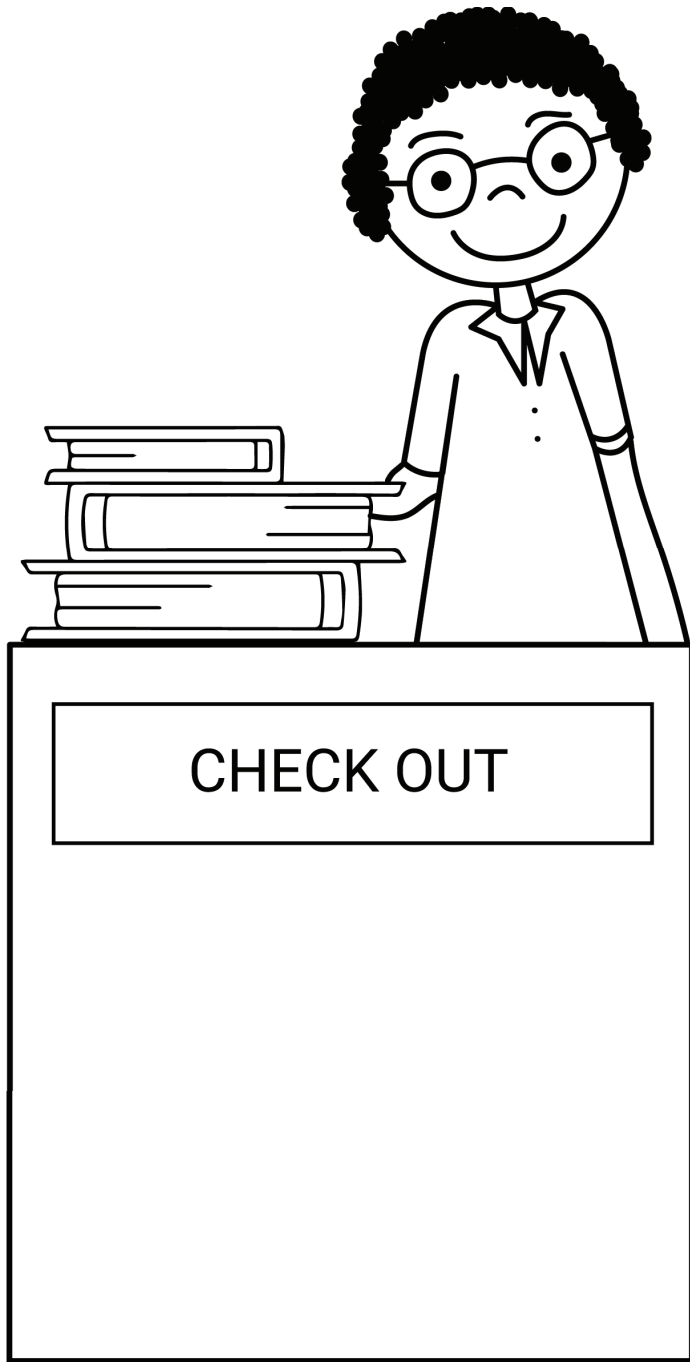
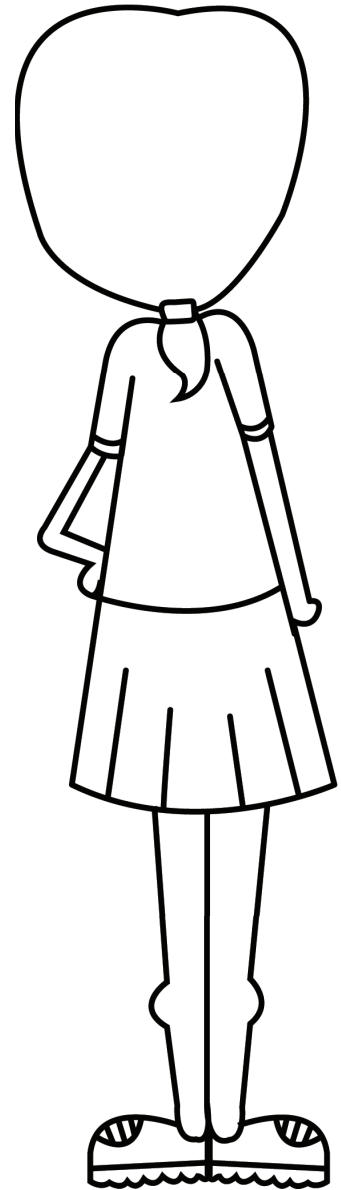

borrow

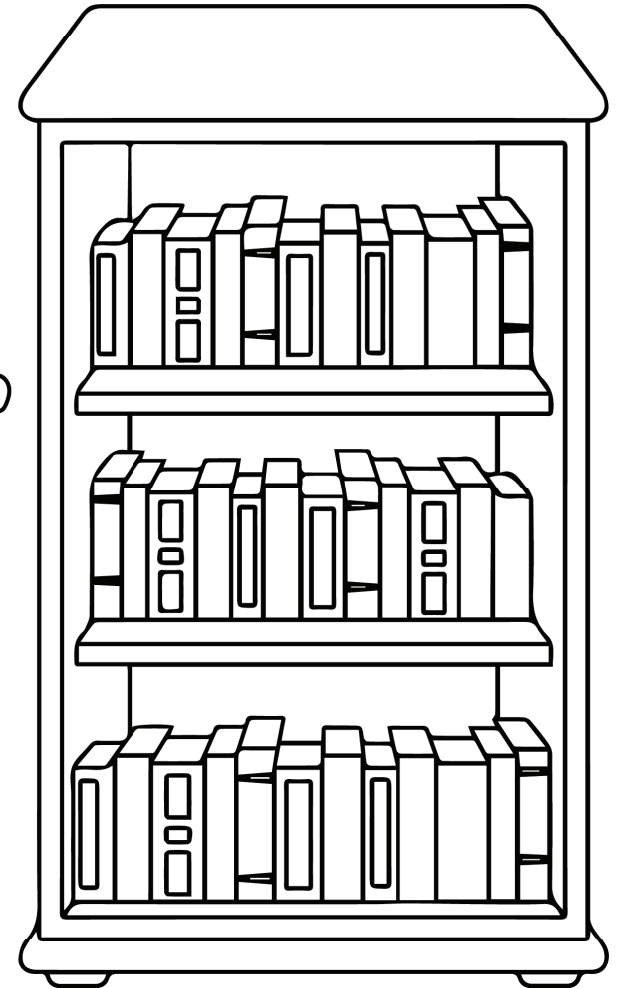
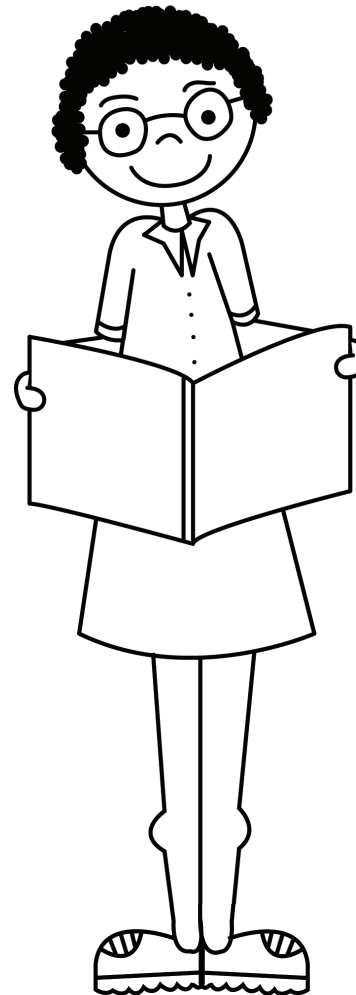
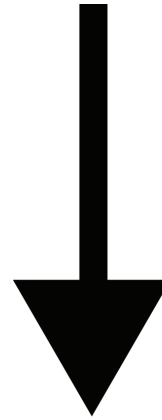

librarian

BOOKSTORE

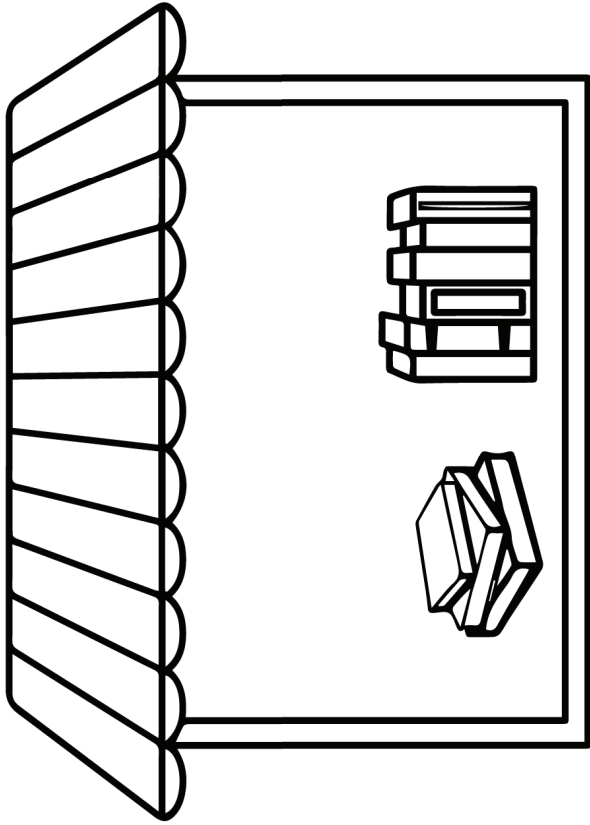
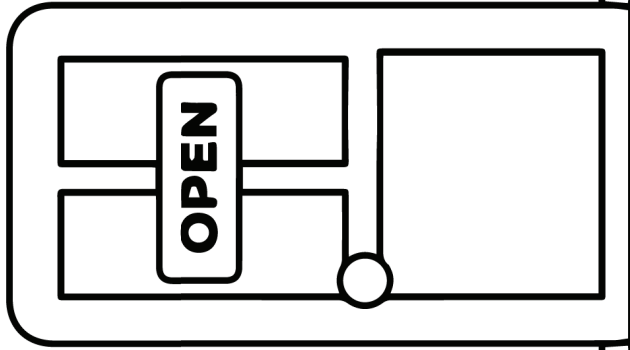

bookstore

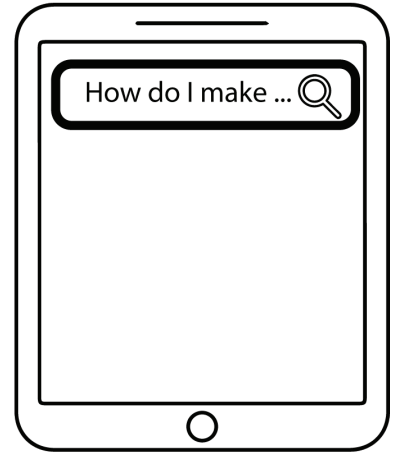
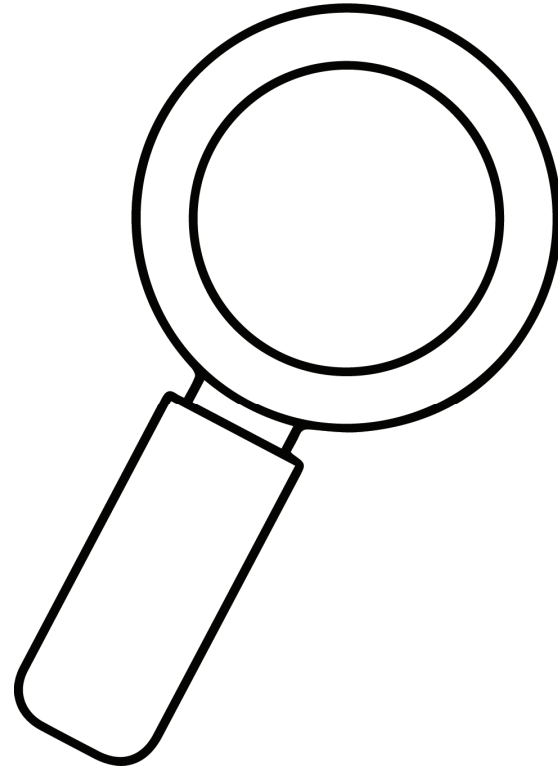
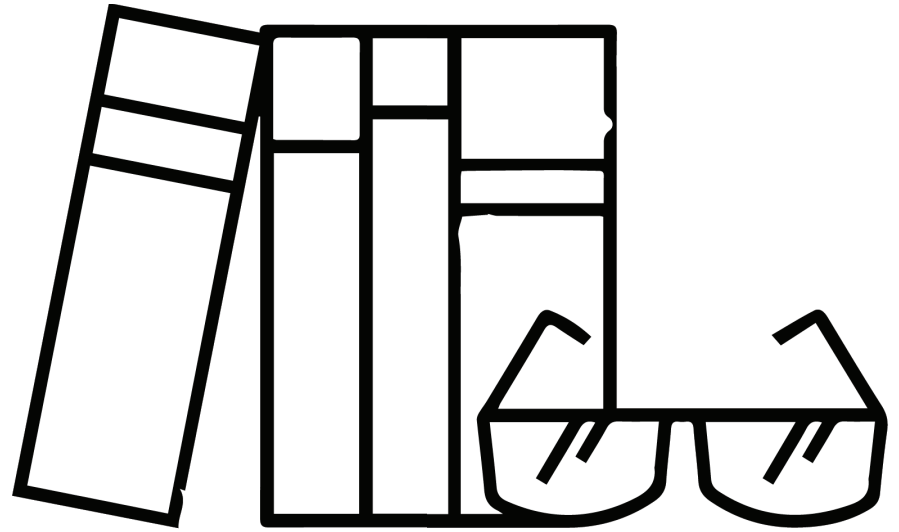

research



cheap

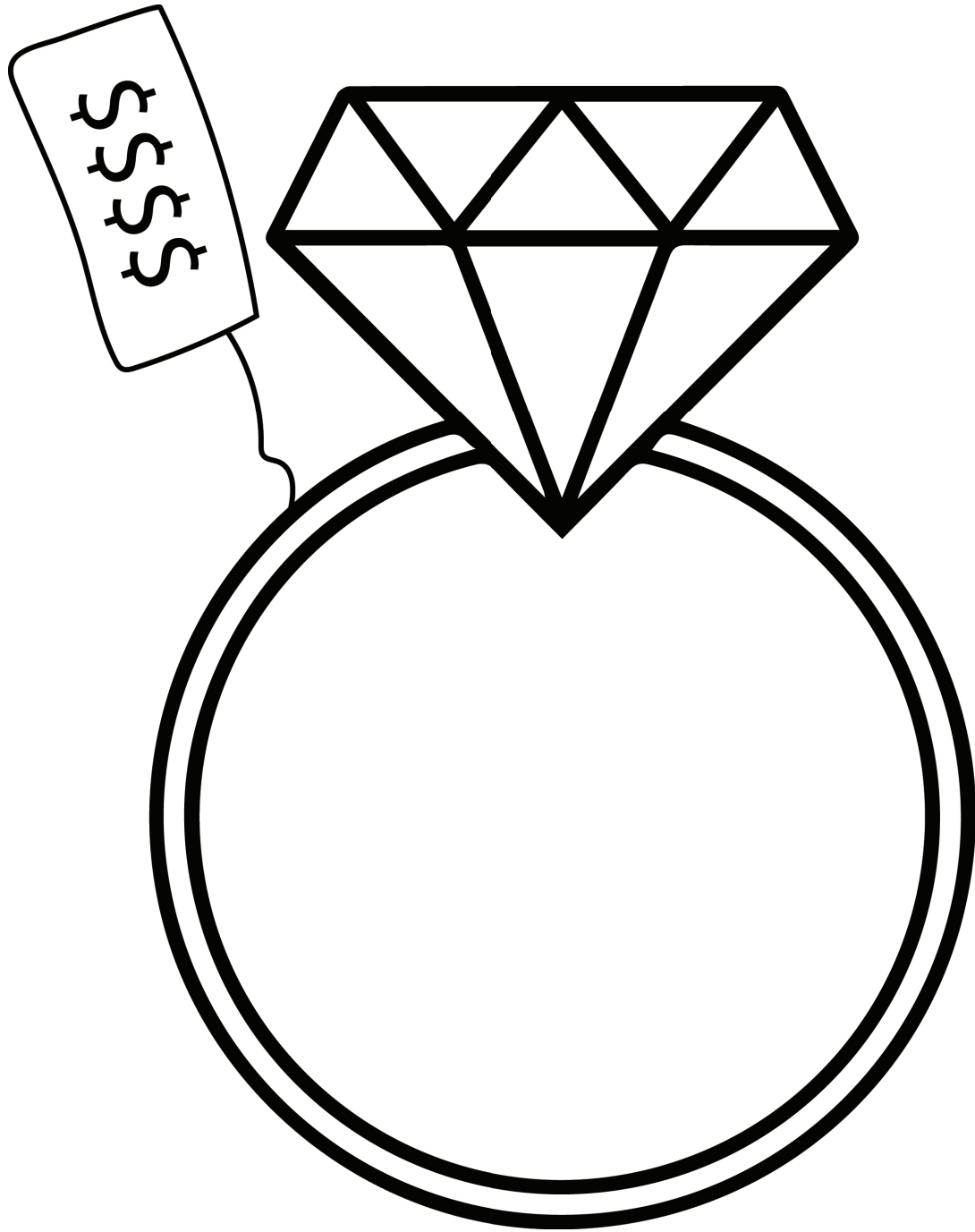

expensive

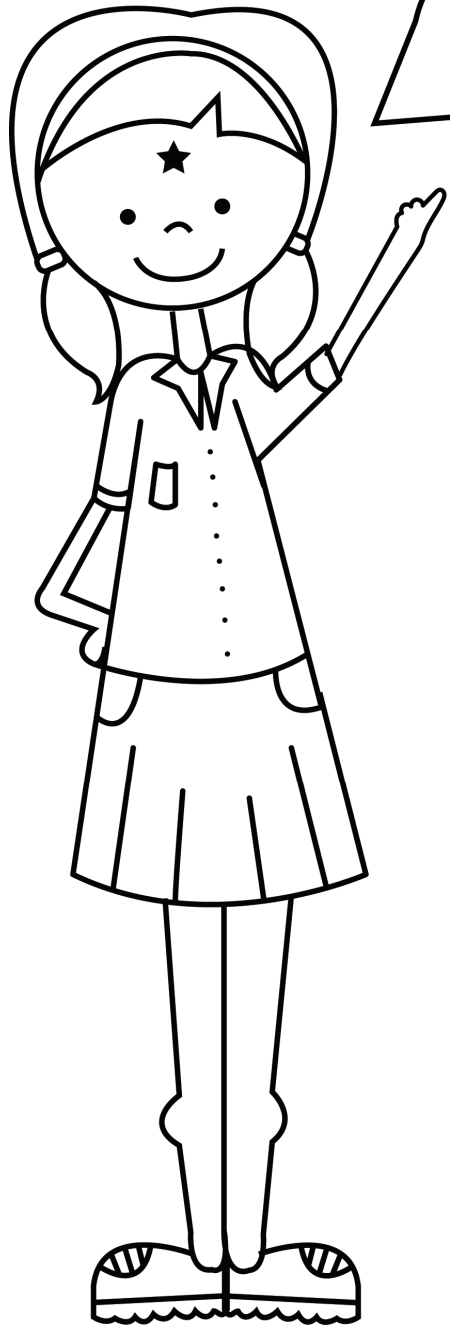

What are
you doing?

ask

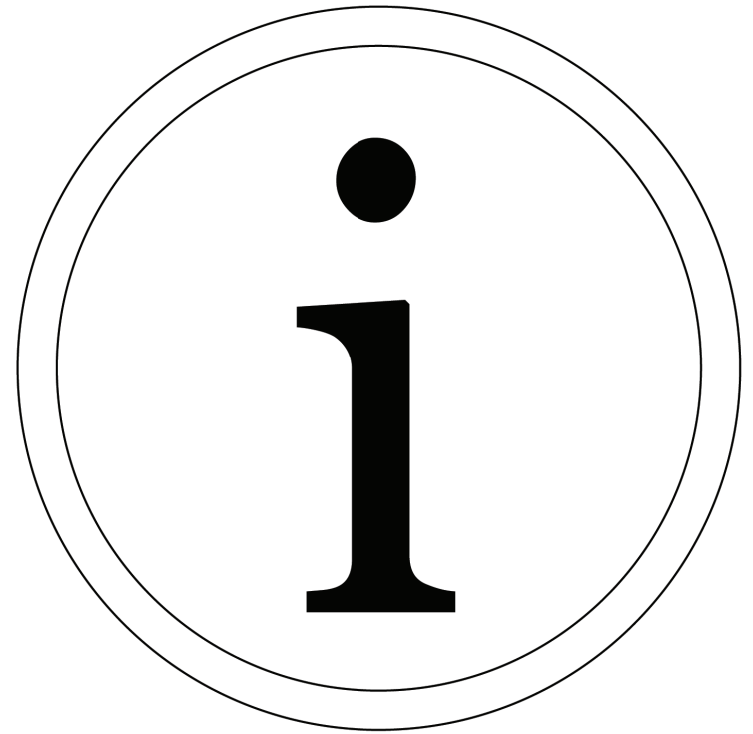
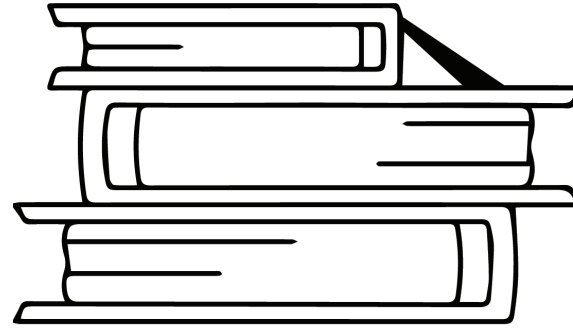

information

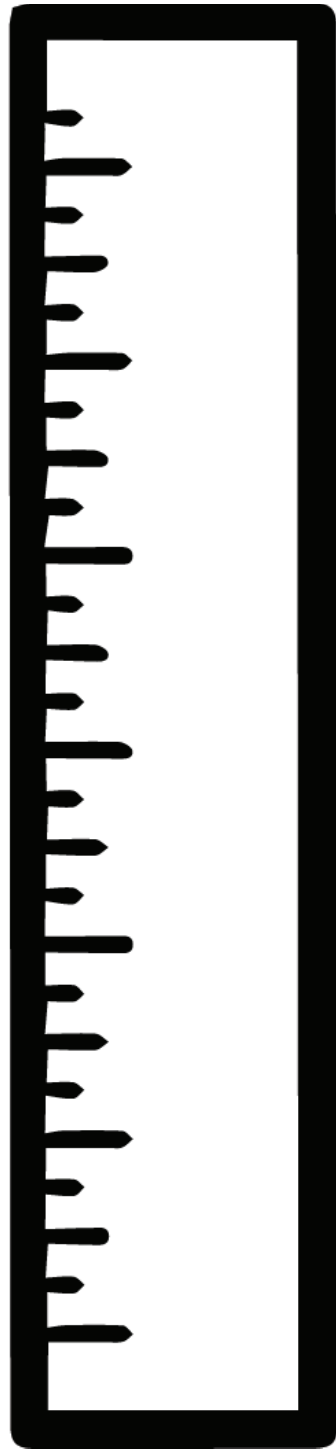
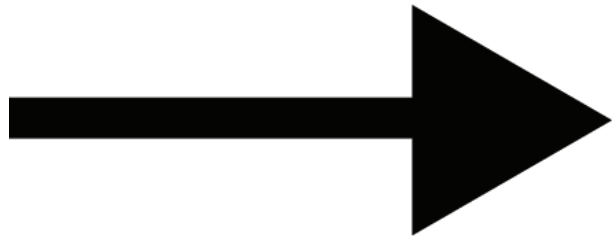

medium

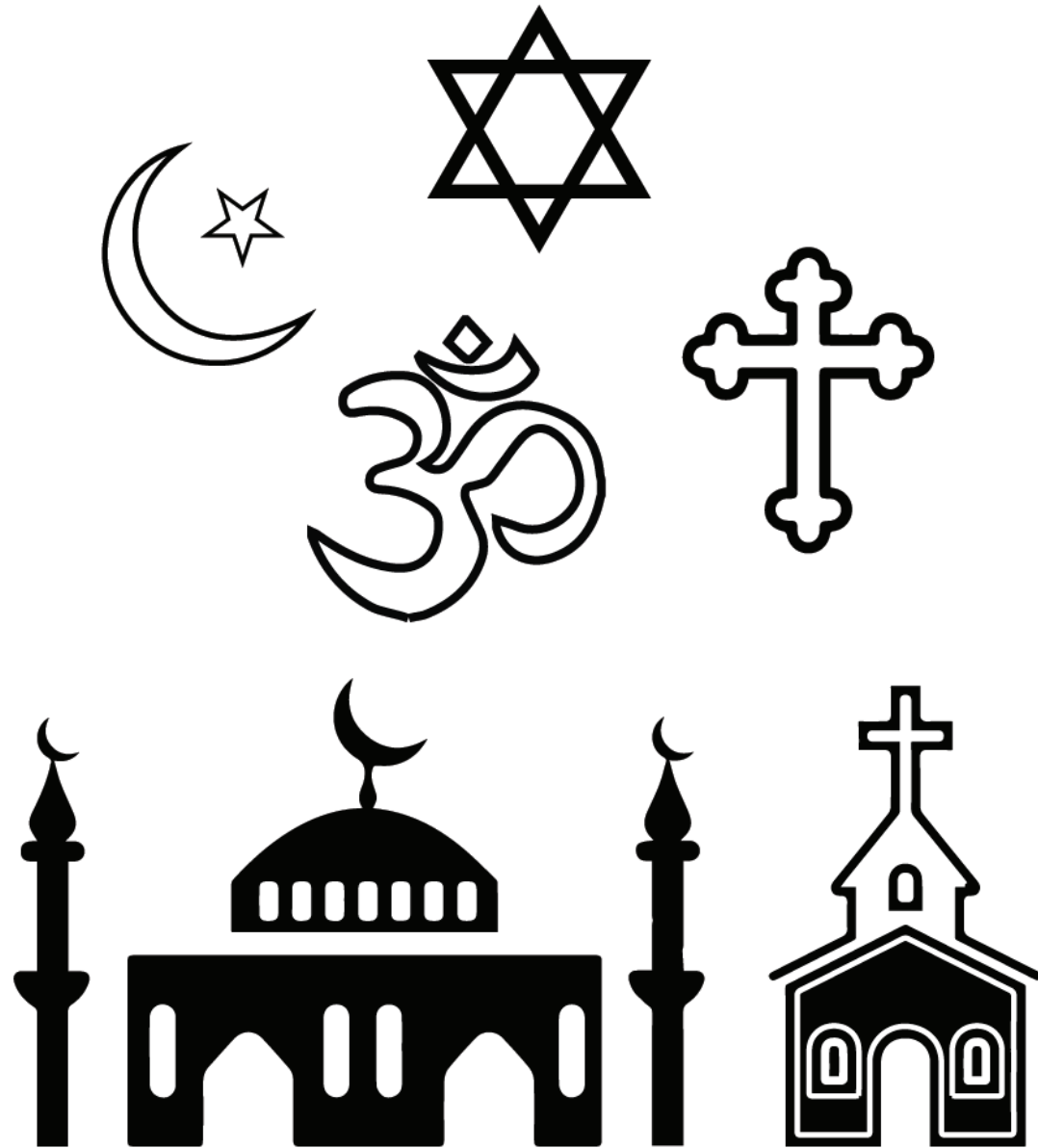

religion

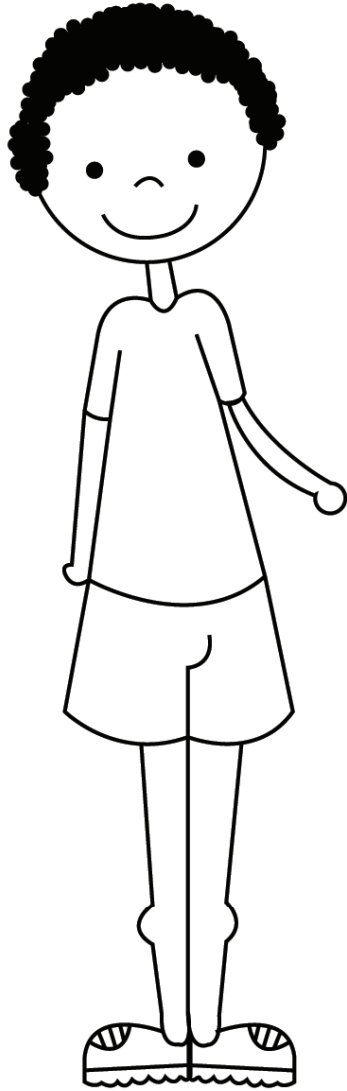
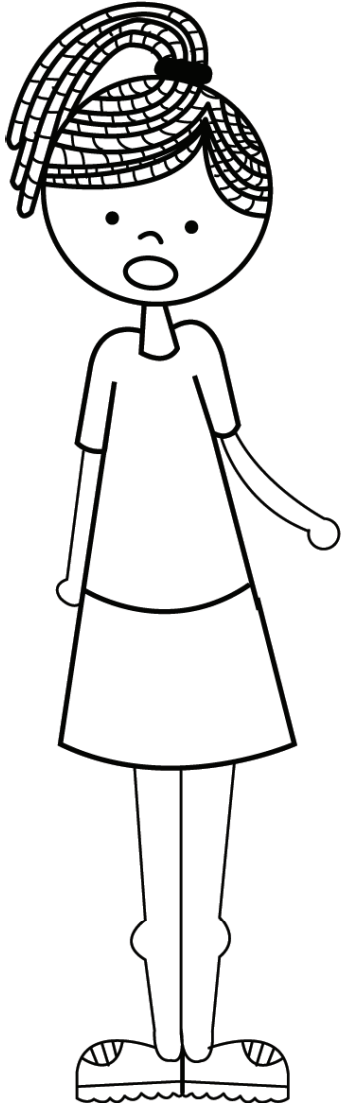
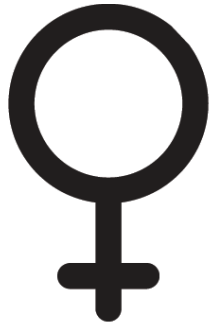

gender

ID CARD

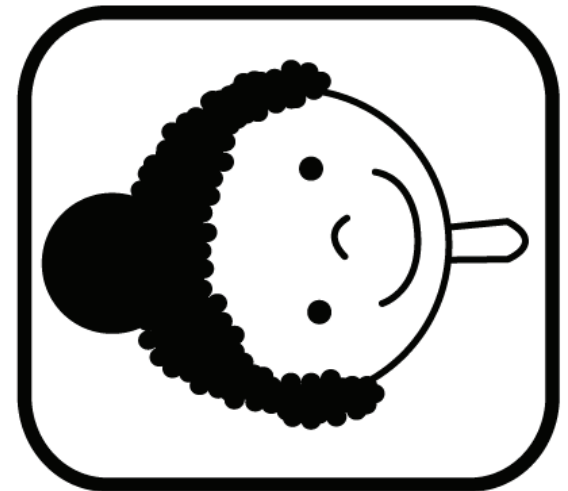

identity

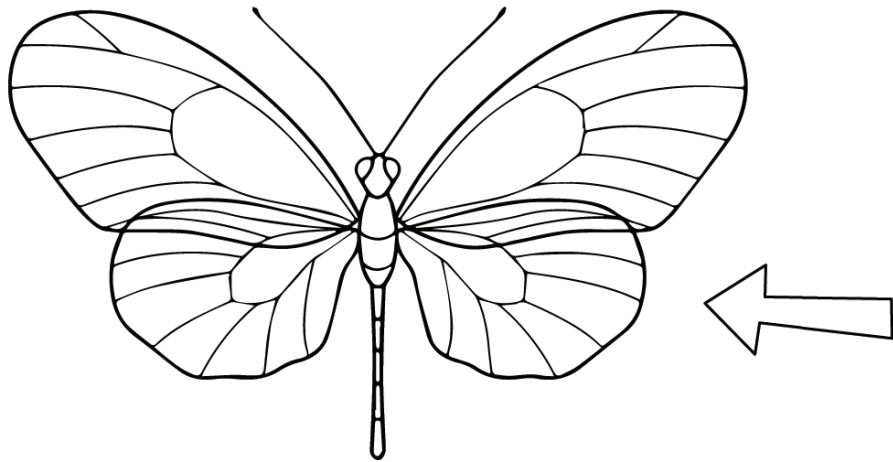
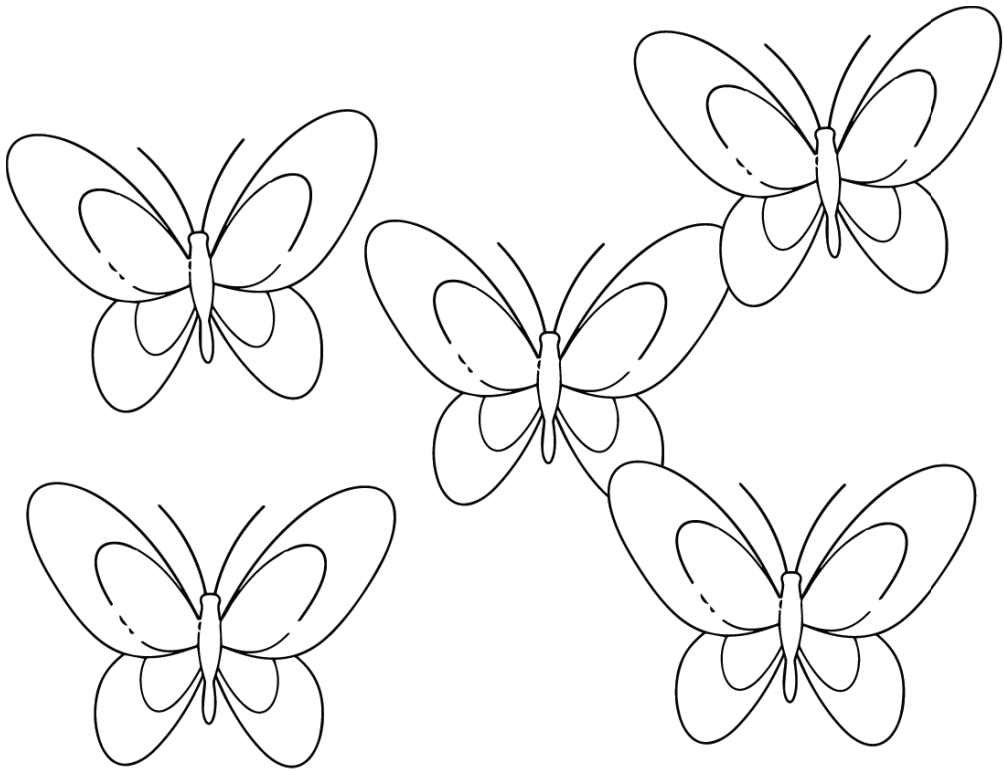

unique

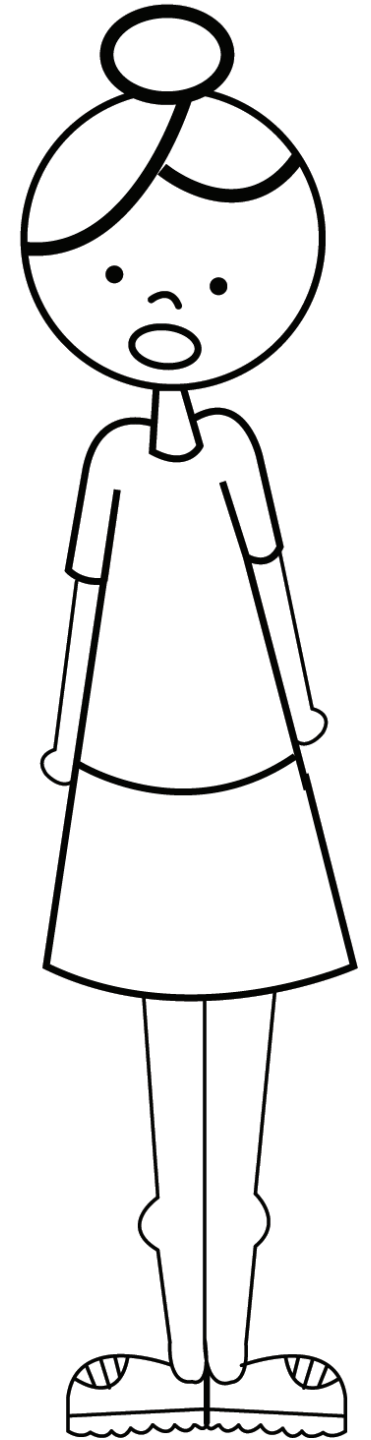
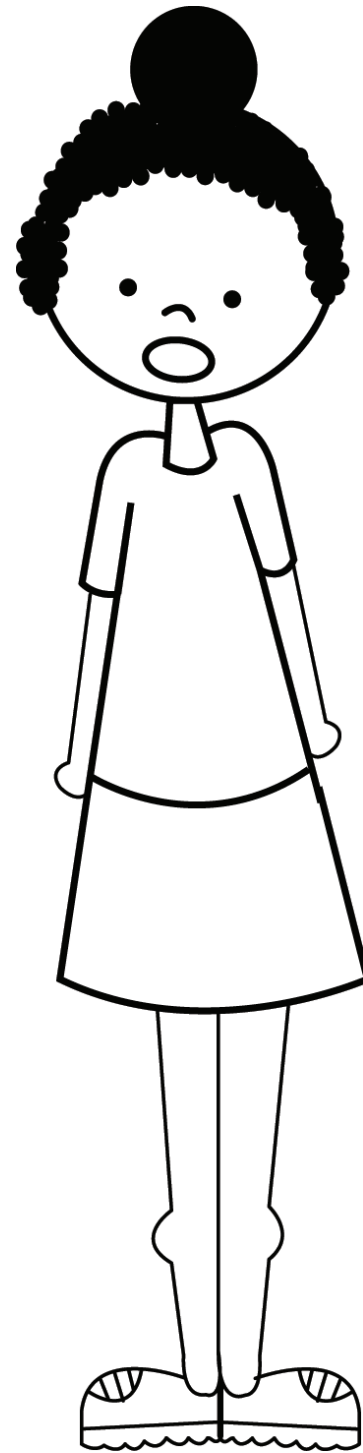

race

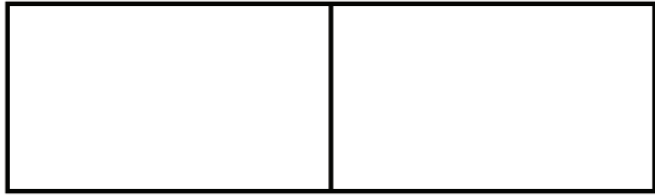

separate

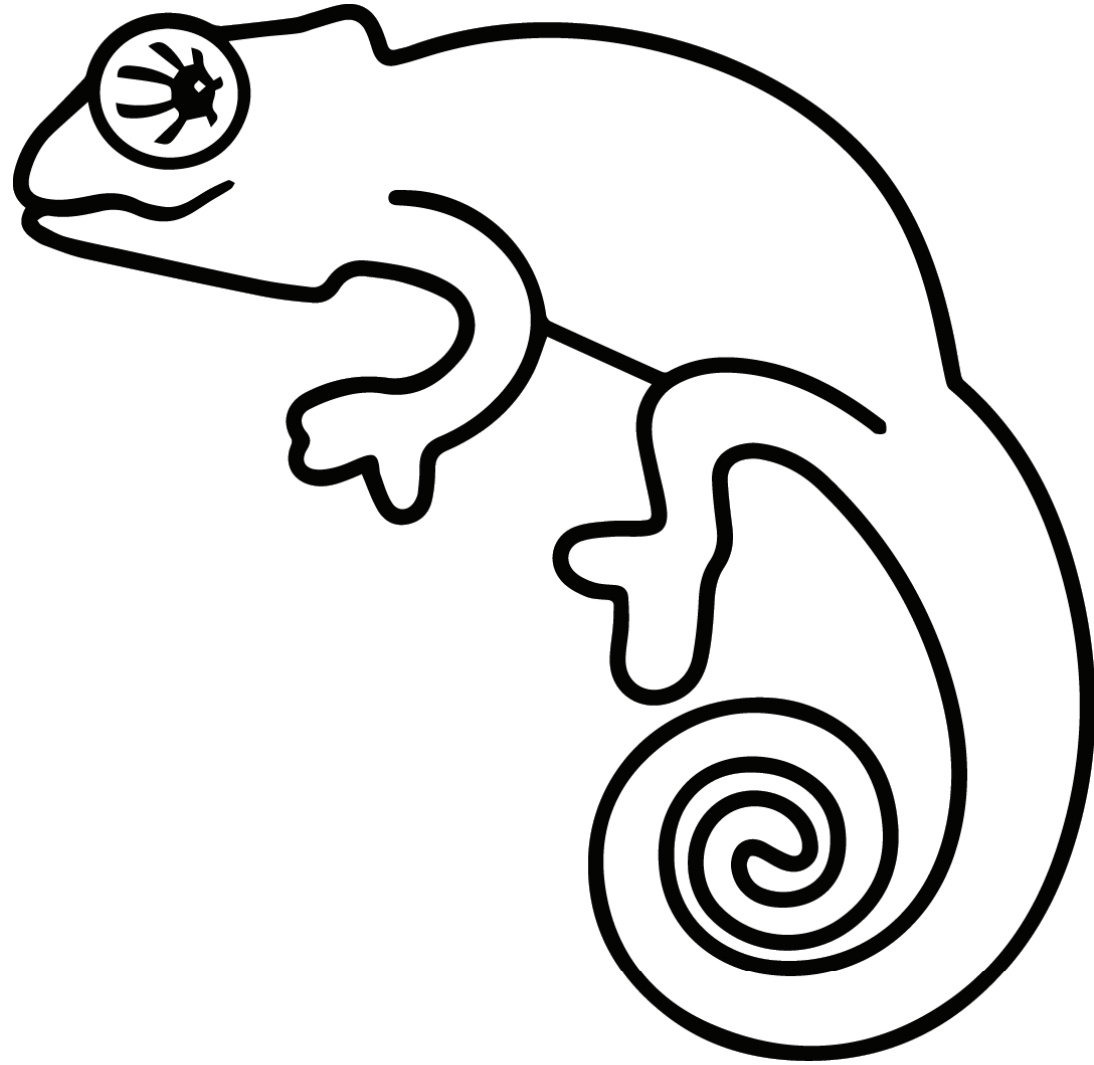

chameleon

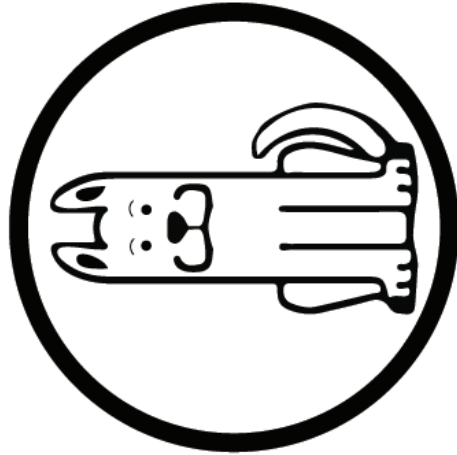
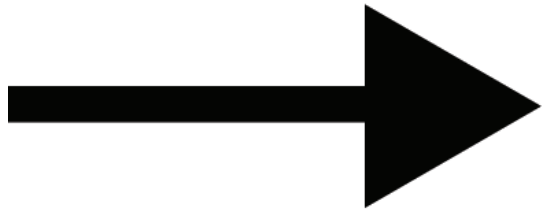

allowed

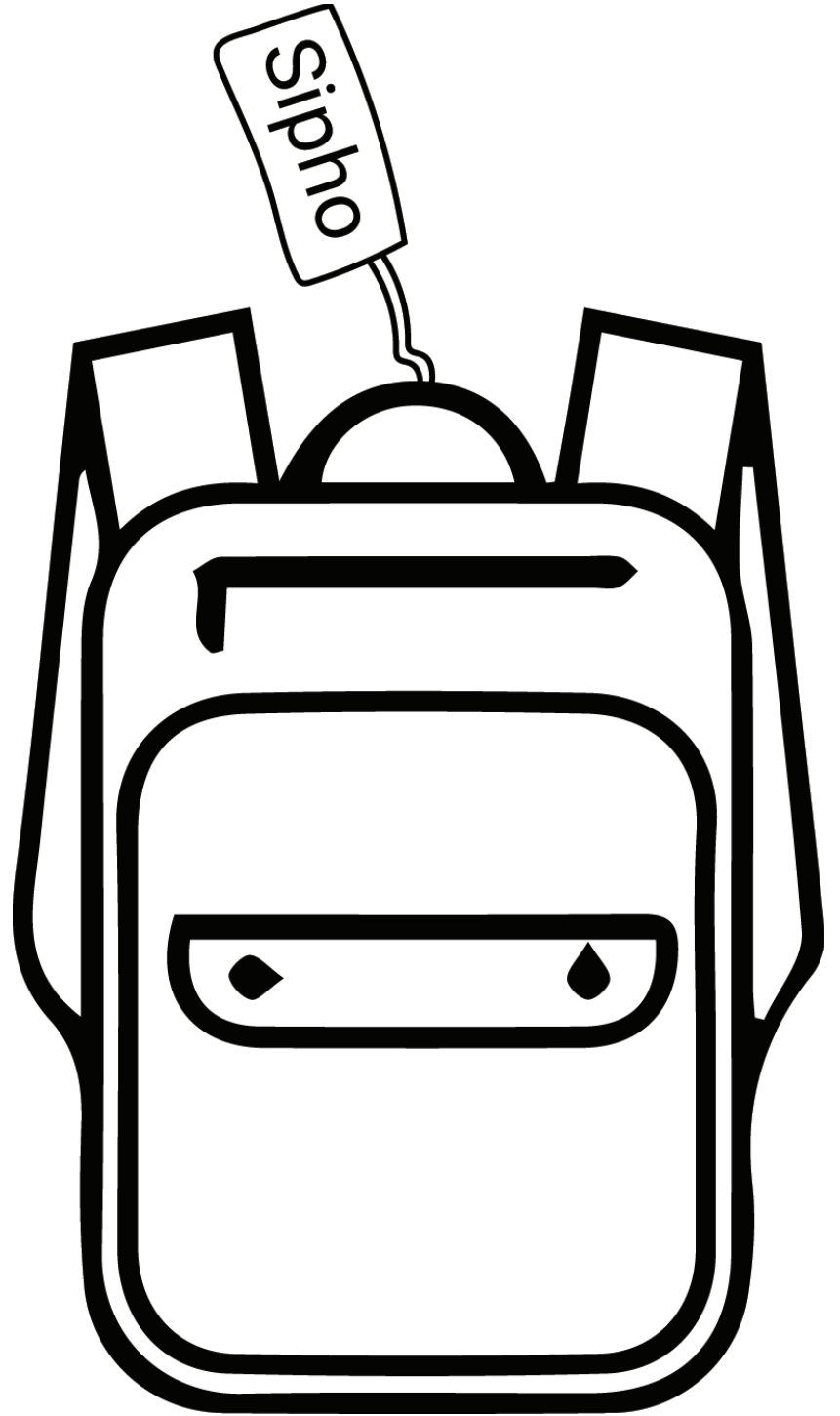

belong

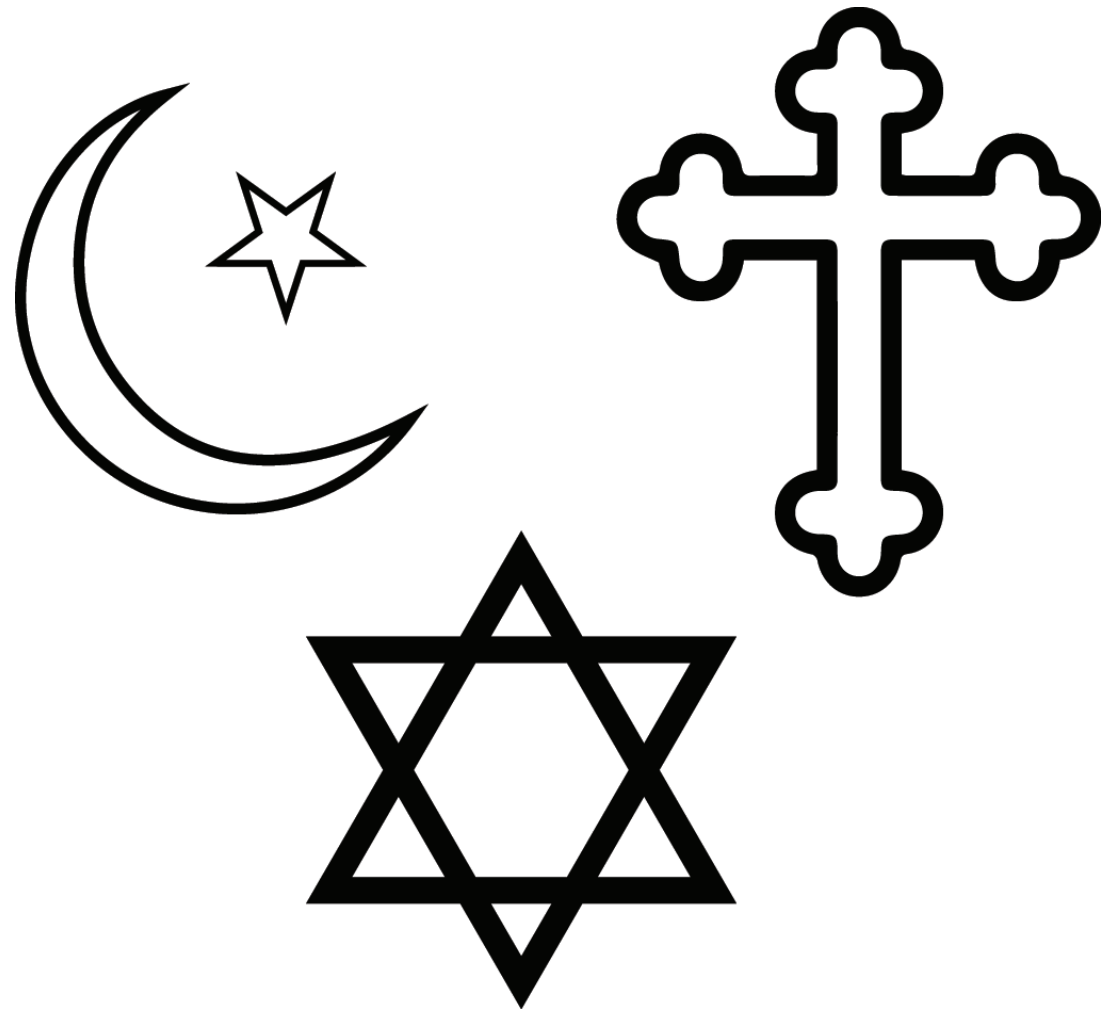

belief

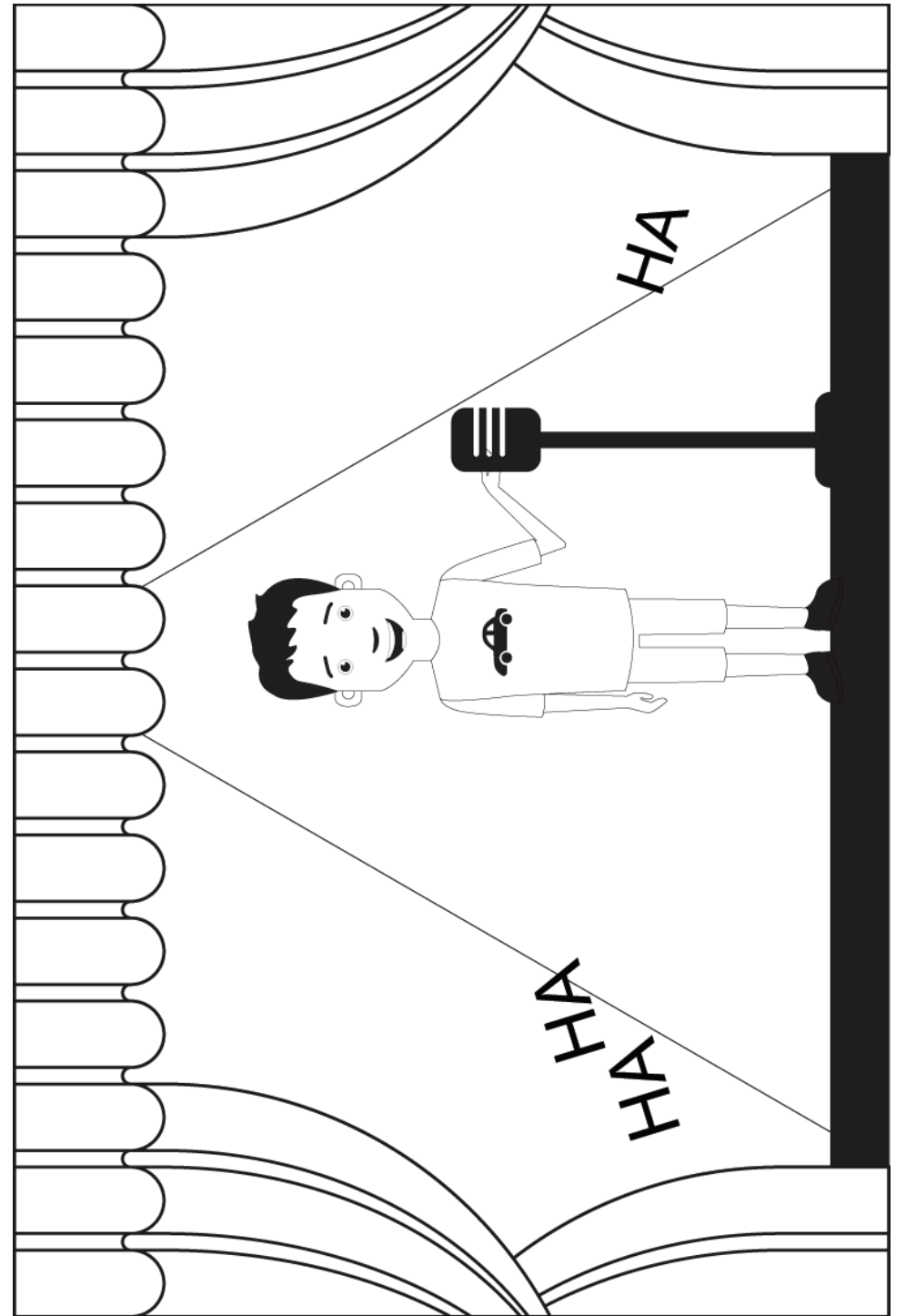

comedian



illegal

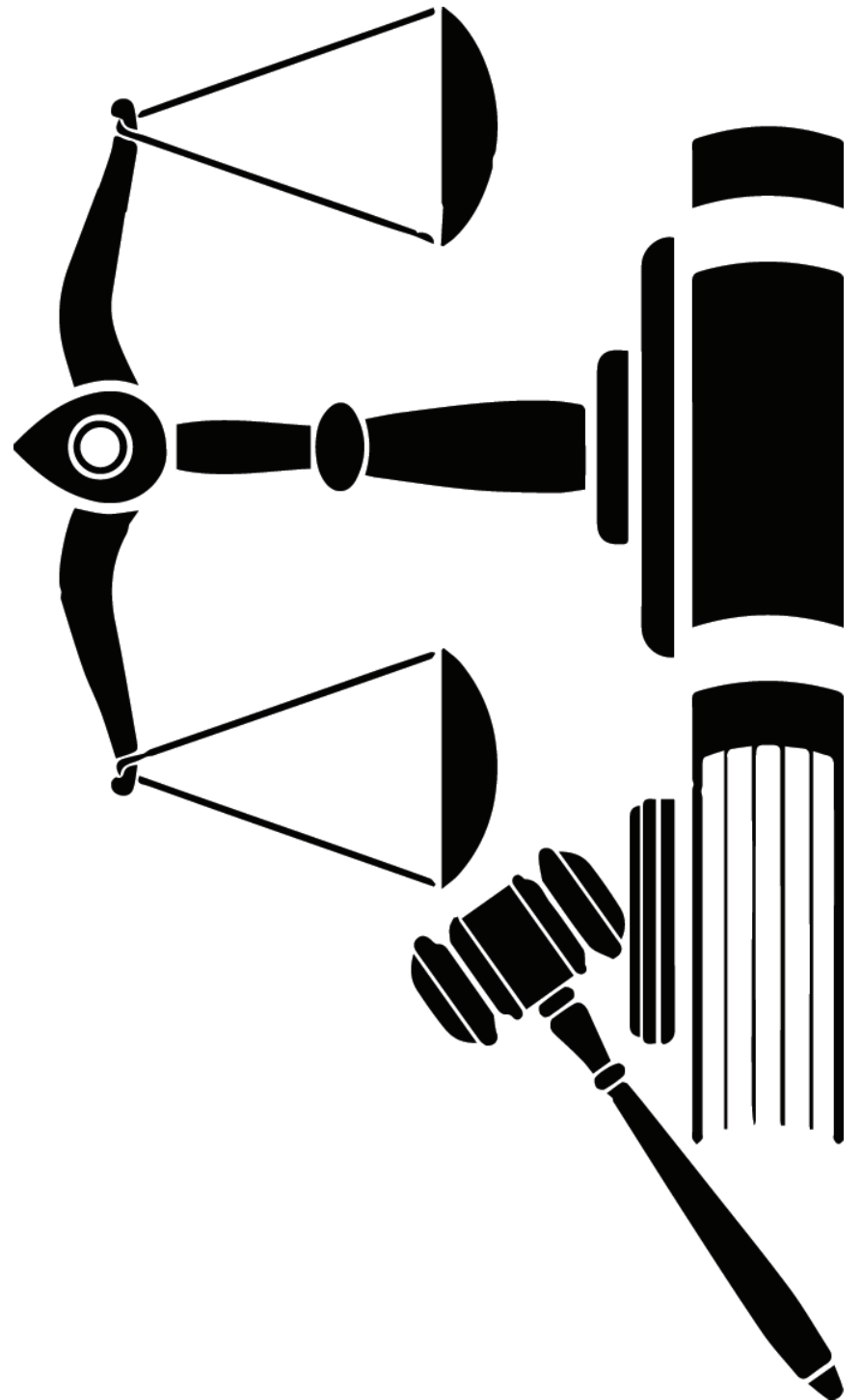

law

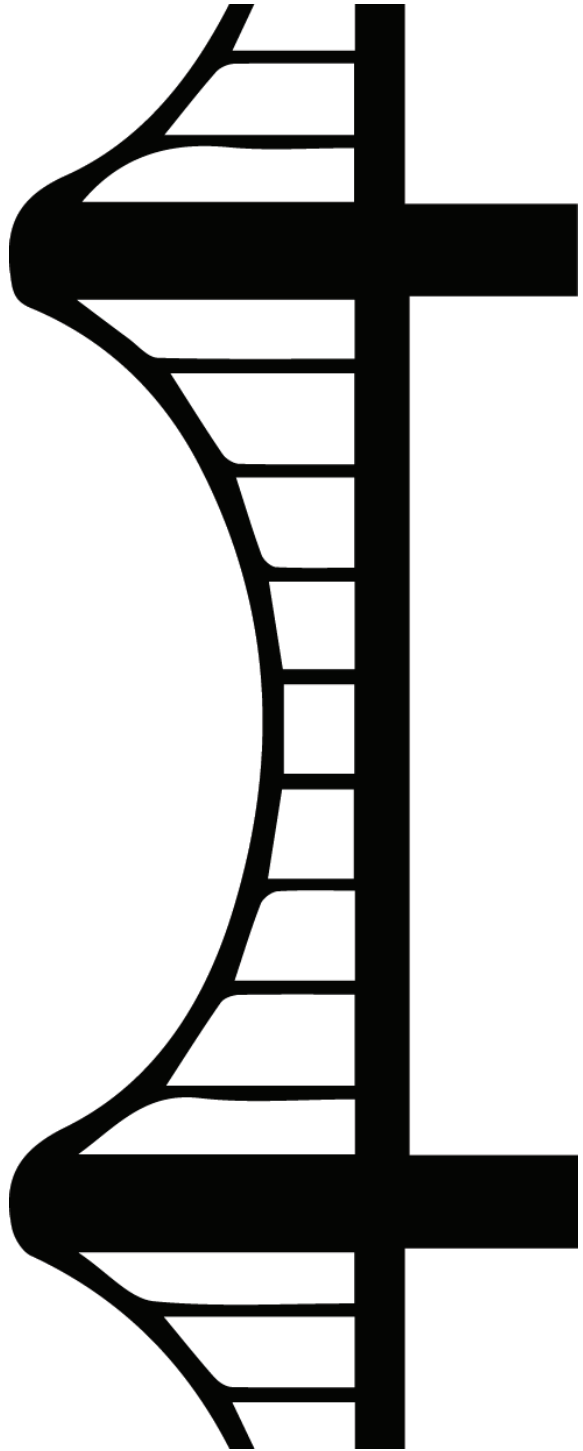

bridge

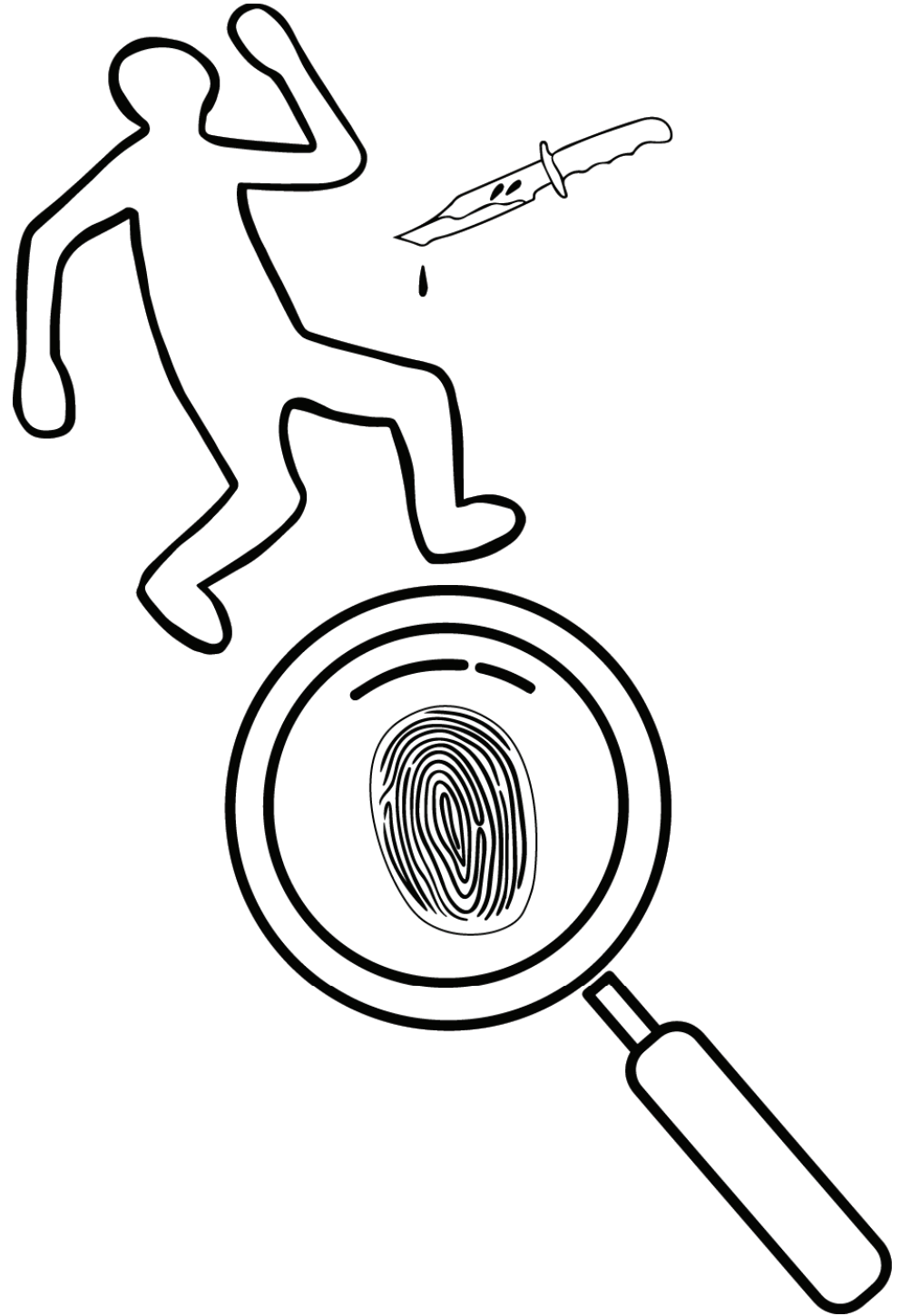

crime

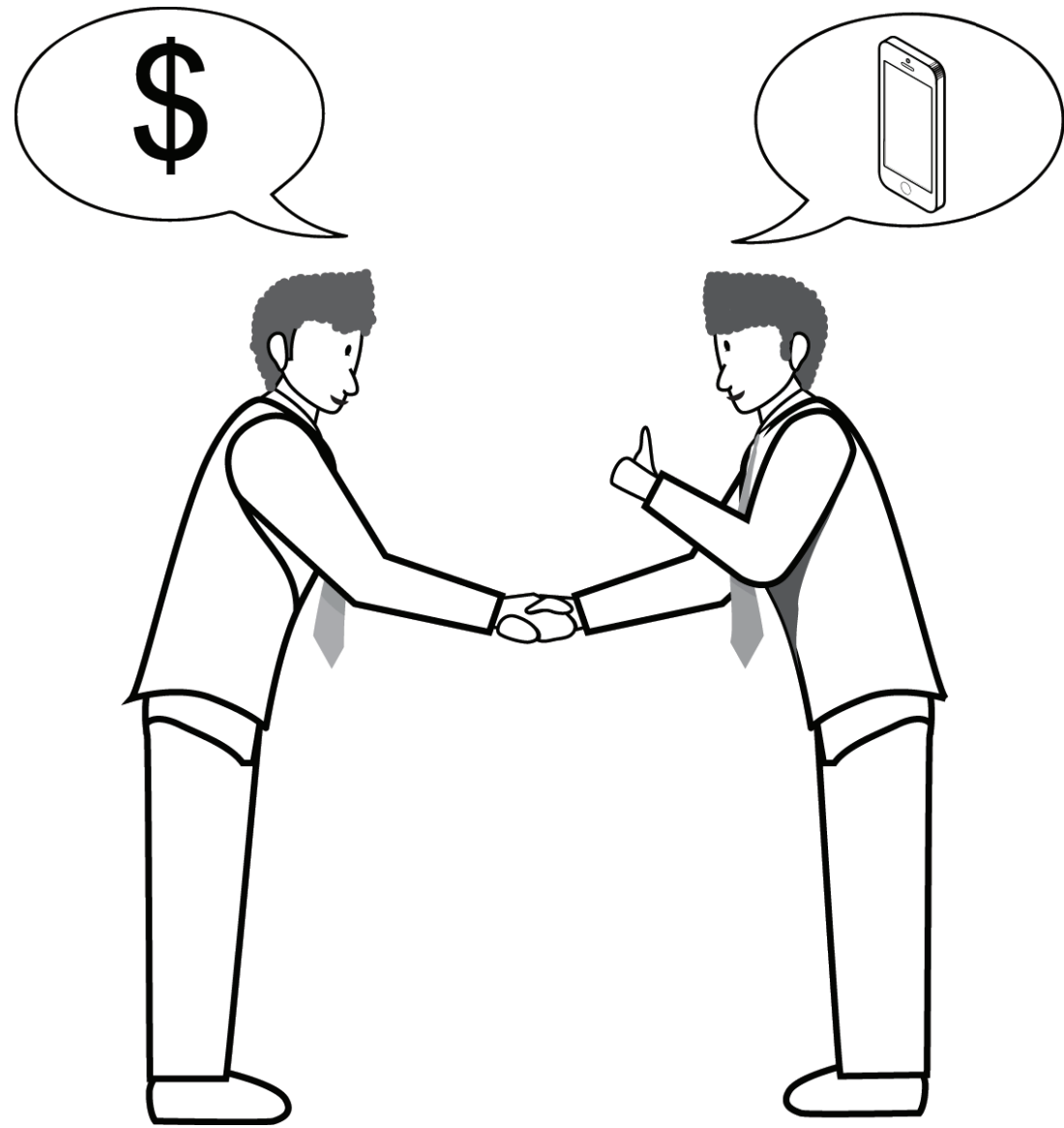

business

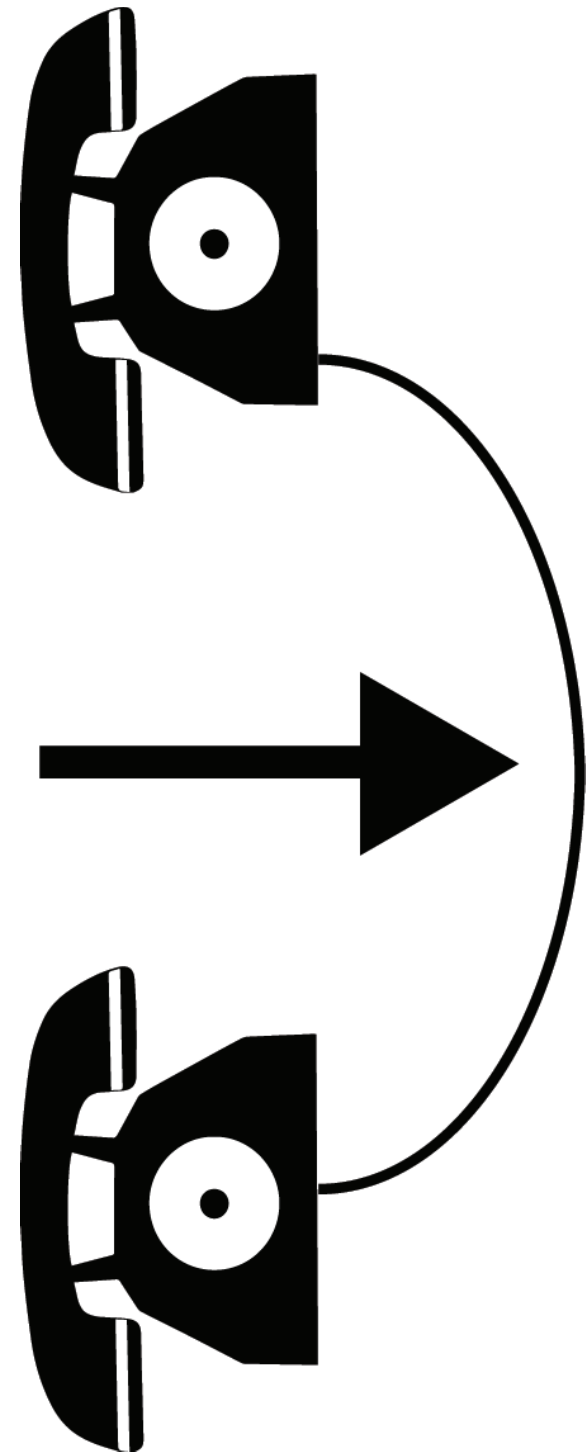

connection

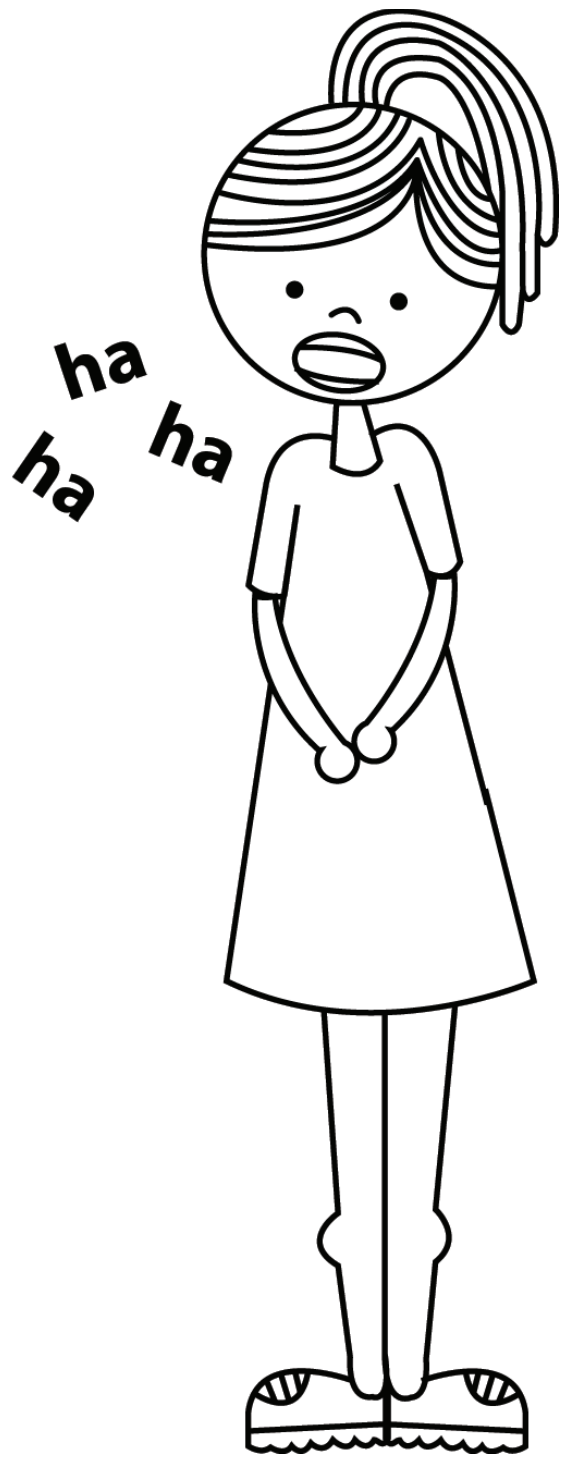

funny

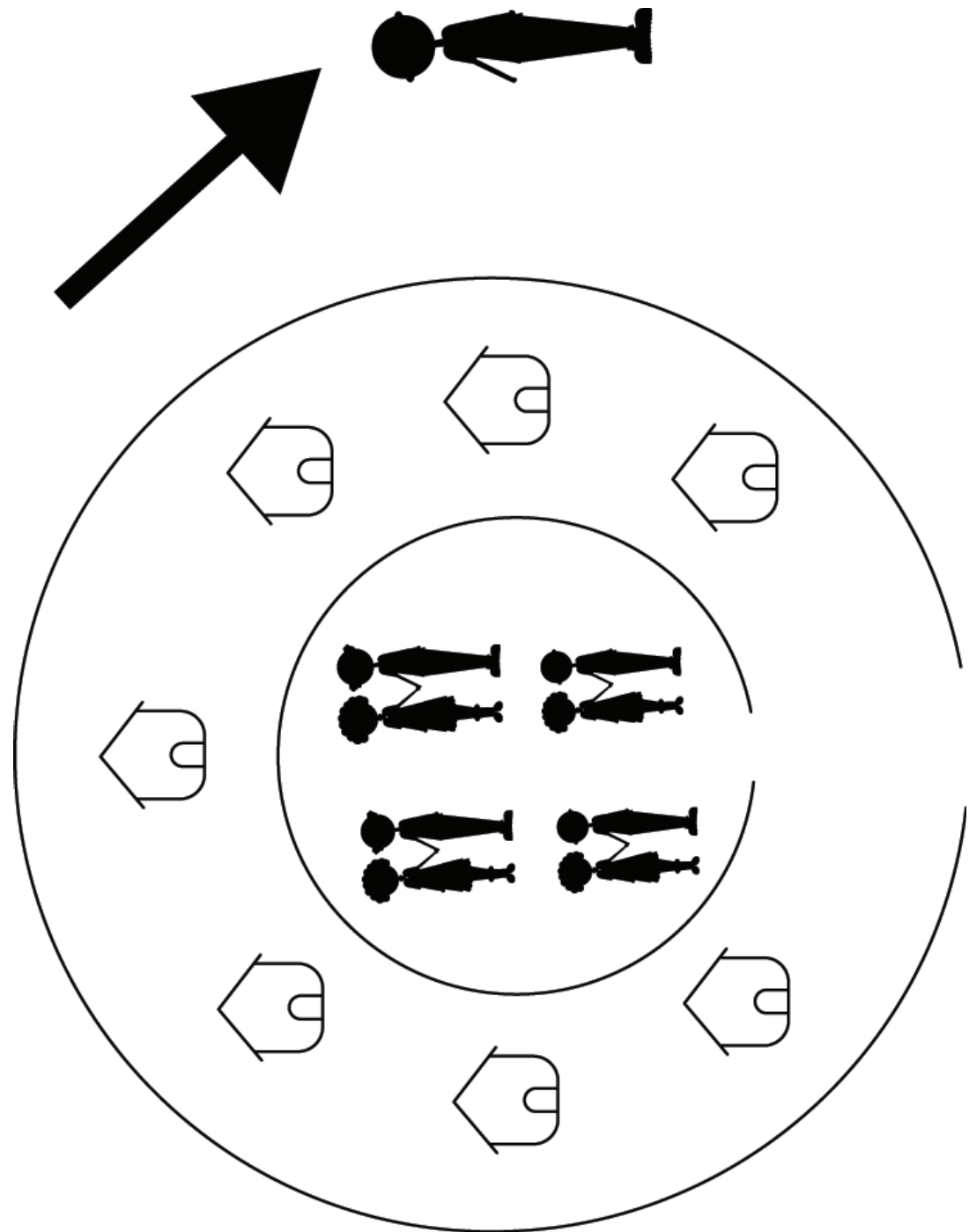

outsider